

INSTRUCTIONS FOR USE

# RAYPILOT SYSTEM

---

0700-7-EN

MICROPPOS  
MEDICAL



# Raypilot System

## Instructions for Use

*Art. no.:* 9020  
*Doc. version:* 0700-7-EN  
*Last modified:* 2024-09-30

**Micropos Medical AB is not liable or bound by warranty if these instructions are not adhered to during installation, operation or maintenance, or if the equipment is modified without written consent from the manufacturer.**

© 2024 Copyright Micropos Medical AB

Micropos Medical AB can accept no responsibility for possible errors in catalogs, brochures and other printed material.

Micropos Medical AB reserves the right to alter its products without notice. This also applies to products already on order provided that such alterations can be made without sub sequential changes being necessary in specifications already agreed.

All rights reserved.

Raypilot® and Hypocath® are registered trademarks of Micropos Medical AB.

The Raypilot System has been manufactured in compliance with IEC-60601-1 (Medical Electrical Equipment).

All other trademarks are the properties of their respective owners.

---

# Table of Contents

<b>1 Introduction</b> .....	<b>9</b>
1.1 Intended Use and Intended Purpose .....	9
1.2 Clinical Benefit and Clinical Performance .....	9
1.3 Device Description .....	9
1.4 Photos of Raypilot System Components .....	10
1.5 Illustrations of Raypilot System Components .....	12
1.6 Photos of Raypilot Accessories .....	13
1.7 Illustrations of Raypilot Accessories .....	14
1.8 System Overview .....	15
1.9 Multi Room Installation Overview .....	16
1.10 Raypilot Software User Interface .....	17
1.11 Definitions .....	20
<b>2 Technical Description</b> .....	<b>21</b>
2.1 Acceptance and Performance Testing .....	21
2.2 Recurrent Testing and Maintenance .....	21
2.3 Critical Characteristics .....	21
2.4 Transport and Storage .....	22
2.5 The Raypilot DICOM-RT Interface .....	23
2.6 Communication .....	23
2.7 Safety .....	30
<b>3 Safety</b> .....	<b>31</b>
3.1 Target Group .....	31
3.2 Installation and Service .....	31
3.3 Educational Requirements .....	31
3.4 Warnings .....	32
3.5 Cautions .....	33
3.6 Contraindication .....	33
3.7 Symbols on the Products .....	33
3.8 MR Unsafe .....	35
3.9 Treatment Duration and Patient Sensitization .....	35
3.10 Security .....	35
3.11 Indexing the Raypilot Receiver .....	36
3.12 Environmental Conditions .....	36

---

3.13 Packaging Damage . . . . .	36
3.14 Serious Incident Reporting . . . . .	36
<b>4 Settings . . . . .</b>	<b>39</b>
4.1 Sign In Raypilot Software . . . . .	39
4.2 Administrator's Function . . . . .	40
4.3 Operator's Function. . . . .	44
<b>5 Treatment . . . . .</b>	<b>51</b>
5.1 Set Up Equipment. . . . .	51
5.2 Daily Quality Control . . . . .	53
5.3 Add Patient Transmitter Displacement . . . . .	56
5.4 Add Field Tolerance Parameters . . . . .	59
5.5 Match Patient to Transmitter ID . . . . .	62
5.6 First Treatment with Standard Table Positioning . . . . .	64
5.7 First Treatment with Table Positioning and Image Synchronization . . . . .	72
5.8 Treatment with Standard Table Positioning . . . . .	81
5.9 Treatment with Table Positioning and Image Synchronization . . . . .	87
5.10 Daily Shut Down Routine . . . . .	94
5.11 Storage and Backup . . . . .	96
5.12 Multi Room Installation . . . . .	96
<b>6 Maintenance . . . . .</b>	<b>99</b>
6.1 Cleaning Equipment After Treatment . . . . .	99
<b>7 Troubleshooting . . . . .</b>	<b>101</b>
7.1 Equipment Problems. . . . .	101
7.2 Error and Warning Messages . . . . .	101
7.3 Raypilot Transmitter Errors . . . . .	105
7.4 Measurement Noise . . . . .	105
<b>8 Appendix: Performance . . . . .</b>	<b>107</b>
<b>9 Appendix: Classification and Compliance . . . . .</b>	<b>109</b>
9.1 CE Marking . . . . .	109
9.2 Electric Shock Protection . . . . .	109
9.3 Requirements IEC 60601-1. . . . .	109
9.4 Electromagnetic Compatibility and Leakage Current . . . . .	109

---

<b>10 Contact Information</b> .....	<b>113</b>
10.1 Contact Details .....	113
10.2 Technical Assistance .....	113
10.3 Authorized Representative .....	113



---

# 1 Introduction

## 1.1 Intended Use and Intended Purpose

The Raypilot® System is intended for use as an adjunct in treatment planning and radiation therapy, to align and monitor the patient's position relative to the isocentre of a linear accelerator. The Raypilot® System provides accurate, precise, and continuous localization of a treatment isocentre by using Raypilot® Hypocath®, a transmitter located within one lumen of a urinary catheter, for prostate localization and tracking, and automatic patient identification.

## 1.2 Clinical Benefit and Clinical Performance

The Raypilot System including Raypilot Hypocath and Raypilot Viewcath includes following clinical performance;

- accurate, precise, and continuous real-time localization of a target (prostate localization) during radiotherapy, the system display that the target stays within predefined tolerances and alert if the target moves outside the tolerances to let health care professionals stop the radiation and reposition the patient.
- the possibility to perform urethra sparing plans and minimize the dose to the urethra due to the radio-opaque barium line in the catheters,
- the possibility to repeat the bladder filling for a repeatable patient setup before treatment by being designed from an ordinary urinary catheter

The clinical benefits of using the Raypilot System with Raypilot Hypocath utilizing target monitoring, urethra outlining, and bladder filling repeatability is that the intended target receives treatment as planned as well as enabling the choice to plan with tighter margins and higher dosage. This can lead to improved dose coverage for potentially increased curability and minimized radiation to healthy tissue for lower risk of gastrointestinal and genitourinary toxicity.

## 1.3 Device Description

The Raypilot System is limited to professional use only.

The Raypilot System shall only be installed/used inside a shielded room/chamber.

The Raypilot System is an electromagnetic tracking system that measures the transmitter's position in three axes: X, Y, and Z, and in the angles pitch and yaw.

The Raypilot Receiver is indexed on top of the treatment couch of the linear accelerator. The patient is placed on the Raypilot Receiver and the Hypocath is connected to the Raypilot Matching Network.





The Raypilot System can be used for initial setup guidance of the target, before verifying the position according to clinical routines for patient setup. After setup, the system is used for continuous monitoring of the target to verify that it remains in the accepted setup position during radiation delivery. If the target moves out of defined position tolerances, the user can take necessary actions, such as stopping the radiation and repositioning the patient.

With the Patient ID, you can ensure that the right patient is connected at all treatment fractions, once the transmitter ID is matched to a specific patient.

The user has the option of adding the functionality to automatically detect and visualize CBCT and beam on/off events in the Raypilot System.

This manual covers instructions for using the Raypilot System. For information covering the Raypilot Hypocath and the Raypilot Viewcath, see the separate manual *Instructions for use Raypilot Hypocath* and *Instructions for use Raypilot Viewcath*.

## 1.4 Photos of Raypilot System Components

Component	Description	Part no
	Raypilot Receiver (BF applied part)	2020
	Raypilot Extension Plate	2021
	Raypilot Software*	3004
	Raypilot Hypocath (sterile) (CF applied part)	1004
	Raypilot Viewcath (sterile)	1005

Component	Description	Part no
	Raypilot Transmitter Cable (blue)	6001
	Raypilot System Cable (green)	6002
	Raypilot Matching Network	6004
	Raypilot Power Box	6003

Table 1 Photos of Raypilot Components

## 1.5 Illustrations of Raypilot System Components

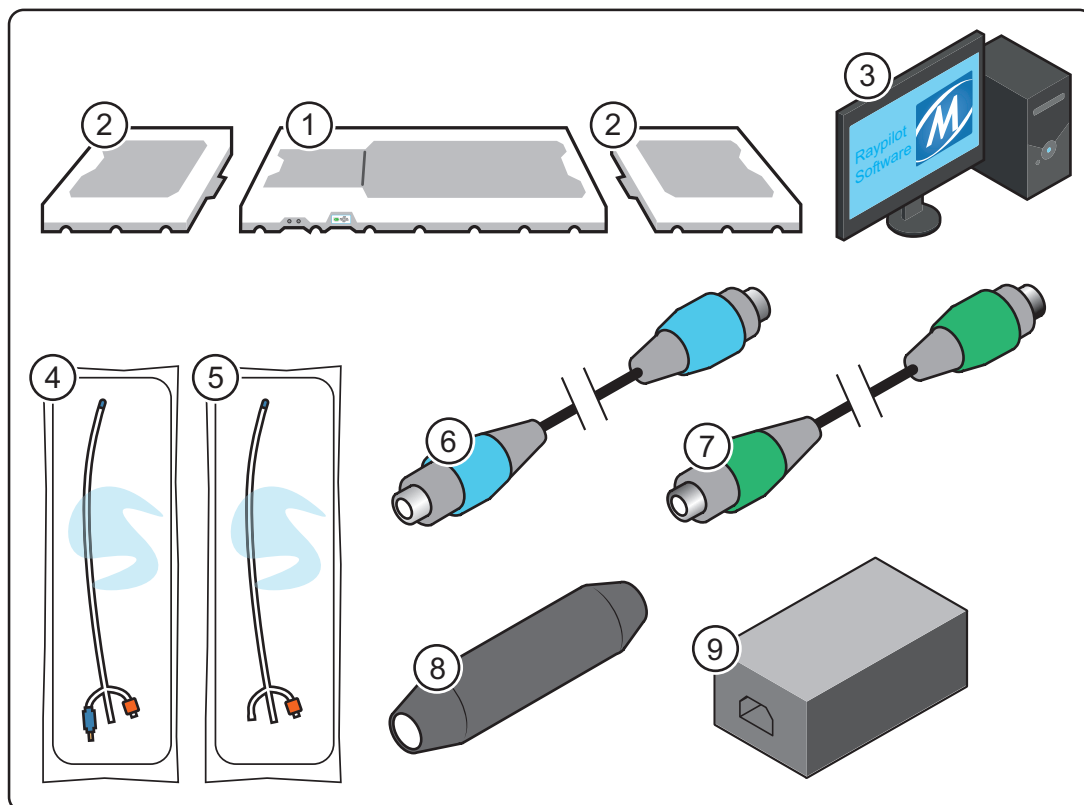

Figure 1 Raypilot System components

No	Description	Part no
1	Raypilot Receiver (BF applied part)	2020
2	Raypilot Extension Plate	2021
3	Raypilot Software*	3004
4	Raypilot Hypocath (sterile) (CF applied part)	1004
5	Raypilot Viewcath (sterile)	1005
6	Raypilot Transmitter Cable	6001
7	Raypilot System Cable	6002
8	Raypilot Matching Network	6004
9	Raypilot Power Box	6003

\*Raypilot Software is installed on a computer and visualized on a display in the control and treatment room

Table 2 List of Raypilot System Components in figure 1

## 1.6 Photos of Raypilot Accessories

Component	Description	Part no
	Raypilot Quality Control Kit: <ul style="list-style-type: none"> <li>• QA Tower</li> <li>• QA Base Plate</li> <li>• QC Transmitter, part no 1010</li> </ul>	4005
	Raypilot Table Displacement Meter	4007
	Raypilot Transmitter Tester	4006

Table 3 Photos of Raypilot Accessories

## 1.7 Illustrations of Raypilot Accessories

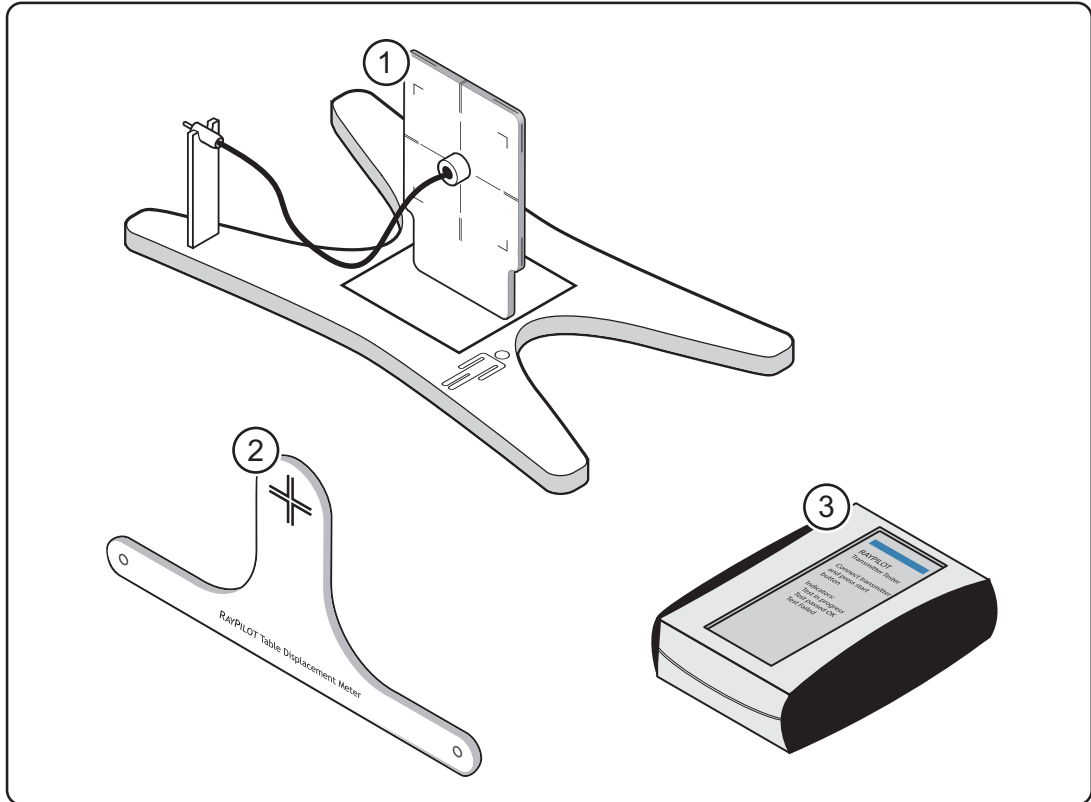

Figure 2 Raypilot Accessories

No	Description	Part no
1	Raypilot Quality Control Kit: <ul style="list-style-type: none"> <li>• QA Tower</li> <li>• QA Base Plate</li> <li>• QC Transmitter, part no. 1010</li> </ul>	4005
2	Raypilot Table Displacement Meter	4007
3	Raypilot Transmitter Tester	4006

Table 4 List of Raypilot Accessories in figure 2

## 1.8 System Overview

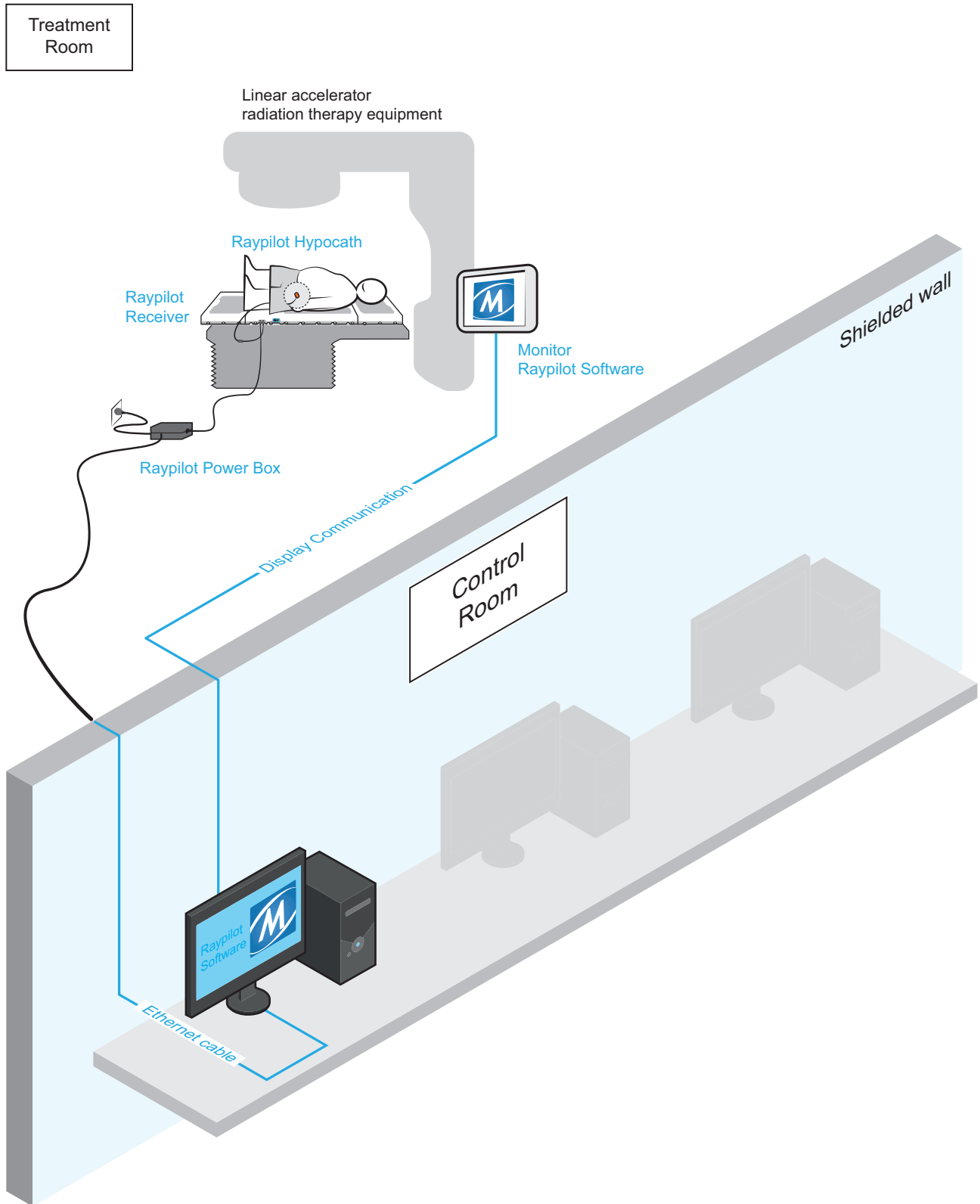

Figure 3 System overview

## 1.9 Multi Room Installation Overview

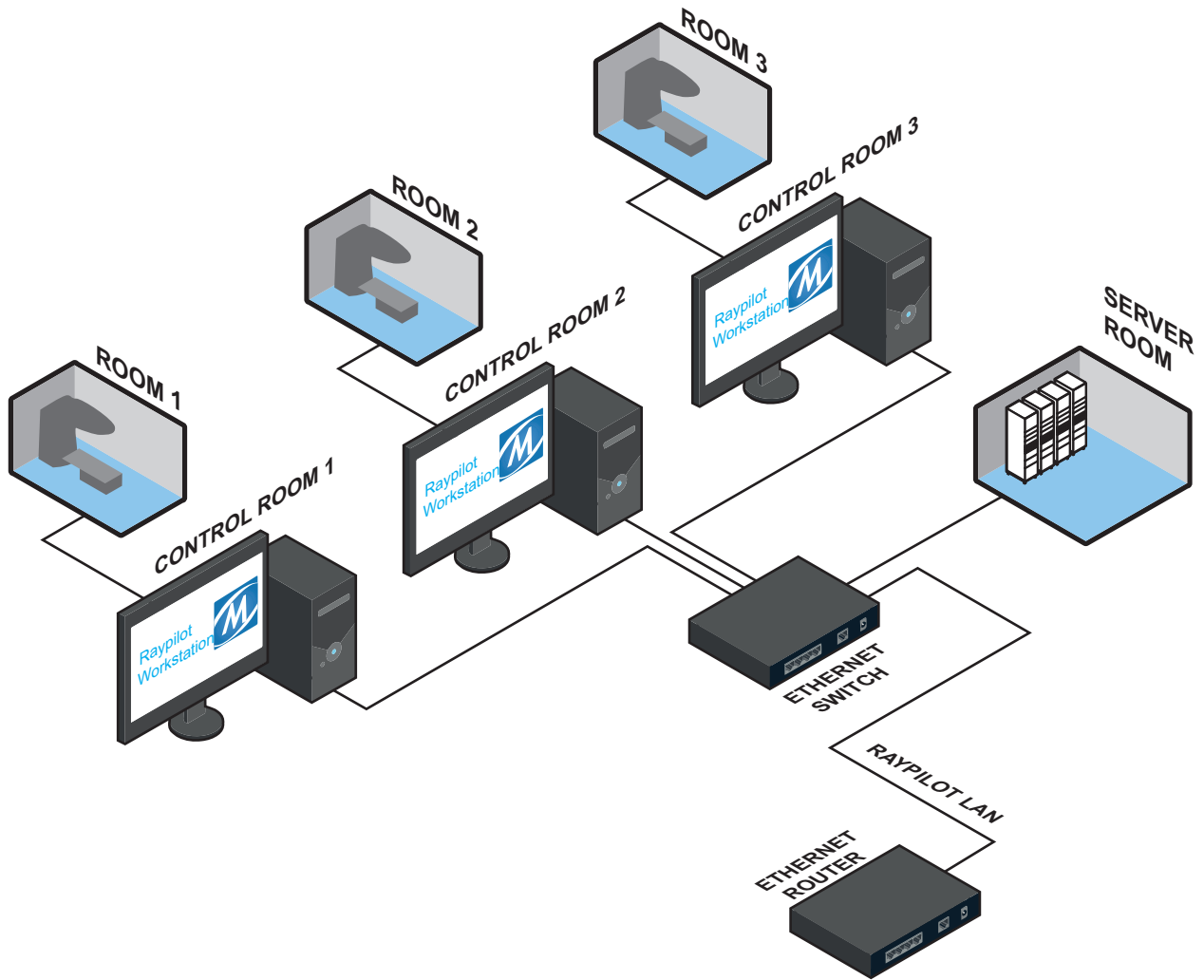

Figure 4 Multi room installation overview

## 1.10 Raypilot Software User Interface

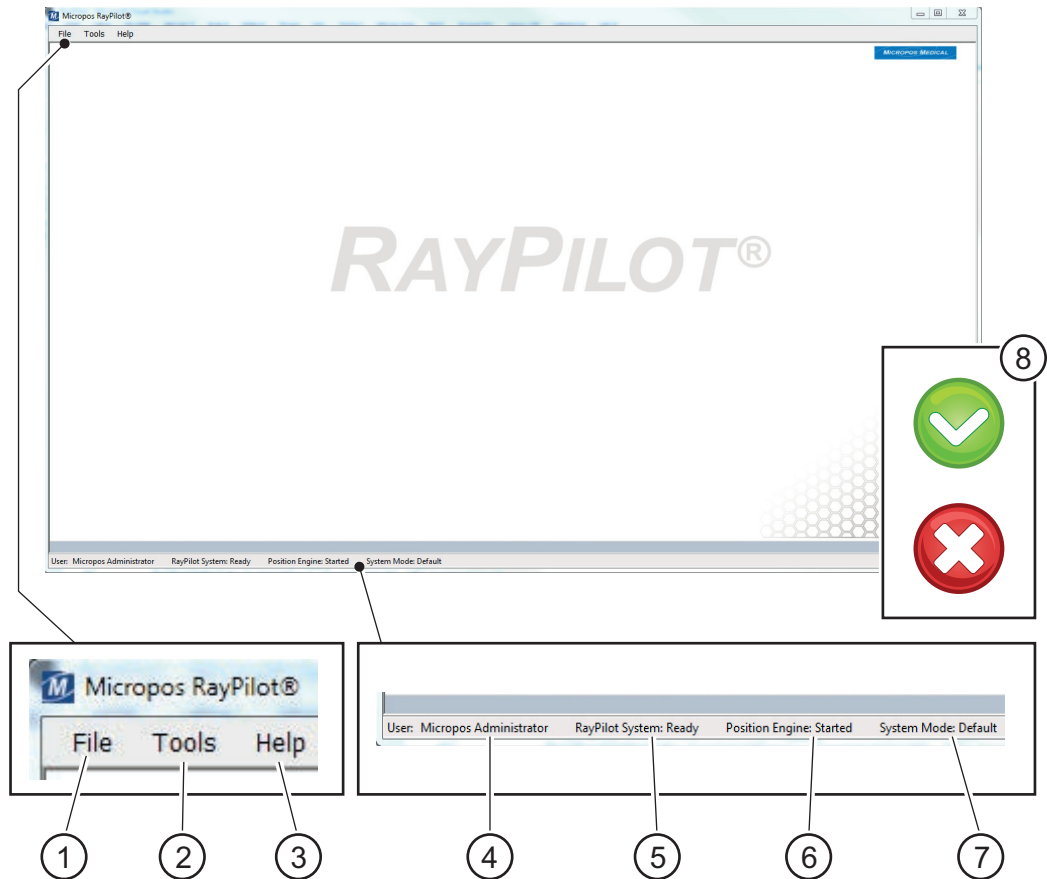

Figure 5 Raypilot Software user interface

No	Function	Description
1	File menu	Start Session, Log In, Log Out and Exit
2	Tool menu	User Accounts, System Status, Measurement Volume 3D, Quality Control, Options, and Extensions
3	Help menu	Information regarding software
4	User role information	Administrator or Operator
5	Raypilot System status	Ready or Not ready
6	Position engine status	Initialized - Position engine is initialized Started - Position estimation is started Error - Error in the position engine
7	System mode information	Current screen
8	Measurement quality indicator	If green - System performance OK If red - System performance not OK, see 7.2 Error and Warning Messages If gray - Transmitter disconnected

Table 5 Functions in Raypilot Software

---

### 1.10.1 Functions

- User login
- Patient database
- Add new patient
- Hypocath<sup>®</sup> Transmitter Monitoring during treatment
- Patient log
- Functional checks of the system
- Detection of interference from external sources
- Import treatment plan
- Automatic patient identification
- Initial patient setup guidance
- Automatic Beam Detection

#### **Note!**

The system continuously logs all usage and saves the information in a log file.

### 1.10.2 Positioning Mode

- **Standard table positioning**  
See 5.6 First Treatment with Standard Table Positioning and 5.8 Treatment with Standard Table Positioning.
- **Table positioning and image synchronization**  
See 5.7 First Treatment with Table Positioning and Image Synchronization and 5.9 Treatment with Table Positioning and Image Synchronization.

### 1.10.3 Software Access

All users of the system need to be authorized by the administrator. The software includes a function for registering new users and setting the user's permissions. There are two permission levels for users of the Raypilot Software:

- **Administrator**  
A representative from Micropos Medical, or Micropos Medical certified, who is responsible for the maintenance of the system. The administrator has full access to all parts of the system. Micropos creates the first administrator at the clinic during installation.
- **Operator**  
Personnel who use the equipment clinically. Access is limited to those functions needed to perform treatment and daily quality control tests.

### 1.10.4 Automatic Patient Identification

Automatic Patient Identification functionality enables Raypilot to automatically open patient data stored in software based on the currently connected transmitter. This requires a matching procedure that is performed by the operator on the first treatment of every patient. On all following treatments, based on the matching between transmitter and patient data, Raypilot Software automatically open previously stored patient data because the transmitter has a unique ID. Only one set of patient data can be matched to a specific transmitter at a time.

If warning messages appear, see 7.2.3 Communication Problem with Automatic Patient Identification.

---

### 1.10.5 Coordinates

All data is stored according to IEC 61217:2011 Radiotherapy Equipment - Coordinates, movements and scales.

#### Note!

Visual data presentation in software, can be configured according to your requirements.

### 1.10.6 Measurement Quality Indicator

The measurement quality indicator is a function that indicates the positioning performance of the system. It turns red to warn for unreliable data. It warns for example if the transmitter is outside measurement volume, if the system is not connected properly or if there is an external disturbance, such as metal objects or incompatible fixation equipment, in the vicinity of the system. The measurement quality indicator is also warning if there is a mechanical failure or degradation in the system which influence the system performance.

### 1.10.7 Import Treatment Plan

With Raypilot Software the patient treatment plan can be imported in DICOM-RT format. The patient treatment plan contains information about the patient and the treatment such as the number of treatment fractions, treatment energy.

#### Note!

The material in the receiver system affects the beam attenuation. Depending on the treatment, the user may want to take it into consideration in the dose plan.

### 1.10.8 Modes

The Raypilot Software can be configured to be operated in different table positioning modes. Only an administrator can change modes before the treatment.

### 1.10.9 Control Panel on the Raypilot Receiver

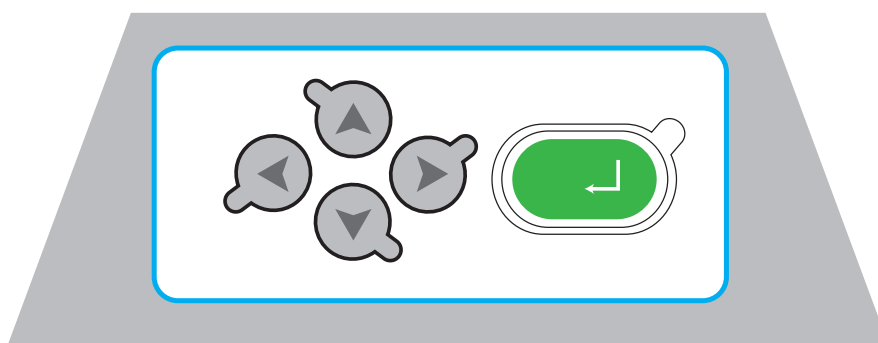

Figure 6 Control panel on the Raypilot Receiver

The control panel on the Raypilot Receiver can control the Raypilot Software. Which button to use is shown on the screen.

### 1.10.10 Automatic Beam Detection

Automatic beam detection is an option that can be added to the Raypilot System. This functionality will enable the Raypilot System to automatically detect start and stop events of

---

CBCTs (Cone Beam CT) with an energy of at least 125 kV as well as treatment beams with an energy of at least 6 MV.

## 1.11 Definitions

Definition	Description
LAT	Lateral direction
LNG	Longitudinal direction
VRT	Vertical direction
Transmitter	Transmitter referencing to the integrated transmitter part of the Raypilot Hypocath. The transmitter sends out a signal to the receiver.
Positioning measurements	All positioning measurements presented in the Raypilot Software are in centimeters (cm) unless otherwise specified.
Positioning point	The tip of the Hypocath Transmitter is the positioning point and is clearly visible on x-ray images such as CT scans used for dose planning.
Marker	Marker referencing to the integrated marker in the Raypilot Viewcath. The Raypilot Viewcath is used for simulating the same situation during treatment planning as with the Raypilot Hypocath during treatment. The marker in Viewcath has the same position as the transmitter tip in the Raypilot Hypocath.

## 2 Technical Description

This chapter contains the technical description of the Raypilot System.

### 2.1 Acceptance and Performance Testing

Information regarding acceptance and performance testing can be found in the accompanying documents that are created for each installation of the Raypilot System.

### 2.2 Recurrent Testing and Maintenance

Recurrent testing of the Raypilot System is done according to the Quality Control routine described in 5.2, Daily Quality Control on page 53. For maintenance, see 6, Maintenance on page 99.

### 2.3 Critical Characteristics

The measurement function is a critical aspect of the Raypilot System. Below is a list of parameters related to the measurement functionality of the system:



Value	Min	Max	Unit	Illustration
Measurement Quality Indicator (Pass/Fail)	Fail (Indicated by red)	Pass (Indicated by green)	Bool	
Measurement Quality Indicator (Numeric Value)	0	∞	1	
Patient Placement Indicator	Lower bound of measurement volume, typically close to -6 cm	Upper bound of measurement volume, typically close to +6 cm	cm	
Pitch/Yaw	Lower bound of measurement angle, typically close to -50°	Upper bound of measurement angle, typically close to +50°	Degrees	
Planned Transmitter Displacement from Isocenter	Lower bound of the selected coordinate system	Upper bound of the selected coordinate system	cm	

Table 6 Critical characteristics.

Value	Min	Max	Unit	Illustration
Isocenter Position	Lower bound of the selected coordinate system	Upper bound of the selected coordinate system	cm	
Transmitter Position	Lower bound of the selected coordinate system	Upper bound of the selected coordinate system	cm	
Patient Table displacement	0	Maximum range is dependent on the coordinate system	cm	
Tolerances	0	∞	cm	
Session Number	1	∞	Session	
Treatment Site	N/A	N/A	Treatment Site	
Field	Range constitutes the fields in the treatment fraction	Range constitutes the fields in the treatment fraction	Treatment Field/Beam	
Treatment Position	Lower bound of the selected coordinate system	Upper bound of the selected coordinate system	cm	
Position Validity	Minimum range is dependent on the bounds of the measurement volume	Maximum range is dependent on the bounds of the measurement volume	cm	
Transmitter Displacement from Selected Reference Point	Minimum range is dependent on the bounds of the measurement volume	Maximum range is dependent on the bounds of the measurement volume	cm	

Table 6 Critical characteristics.

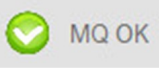
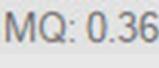
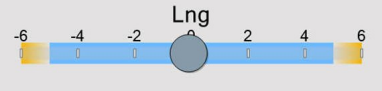
## 2.4 Transport and Storage

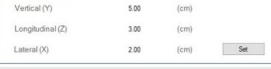
The environmental conditions are only relevant for use and storage since the system is released and tested after transport.

The device is considered safe at a temperature +10°C to +40°C and at a relative humidity level of 30% to 75%. The device is considered safe at an atmospheric pressure range of 70.0 kPa to 106.0 kPa.

---

If the conditions are not met it could influence the measurement precision, and the Raypilot System would give a measurement quality warning.

## 2.5 The Raypilot DICOM-RT Interface

The purpose of the DICOM-RT interface is to provide an automatic transfer of patient data, such as - any locally used patient identification number, patient names, as well as treatment plan specific data, e.g., treatment fields, the isocenter and the location of the center of the Raypilot Hypocath Transmitter tip within the prostate. The information is one-way and transferred from the clinic's treatment planning system to Raypilot. The DICOM-RT interface does not control any external medical devices or accessories.

The intended user of the DICOM-RT interface are technical operator staff and medical physicists.

## 2.6 Communication

The interface works as a DICOM Service Class Provider and employs a regular TCP/IP protocol over standard ethernet – IEEE Standard 802.3 – By default on TCP port 104, and using the AE Title RPR.

The only data transferred from the DICOM-RT interface is the RT Plan and RT Structure set. No CT slices or dose objects. Therefore, the connection has no significant bandwidth requirements, and the bandwidth specification can be considered very low.

No additional knowledge is required besides basic ethernet network administration knowledge.

All actions related to connecting or disconnecting the Raypilot System, to/from the IT-network shall be performed by consulting the Micropos Medical personnel.

During a change of the treatment planning system, the clinic should be prepared to know that the method of marking structures in their treatment planning system, as well as the method of exporting plans, may change, and they should therefore consult the manual.

### 2.6.1 Data Transfer

The data attributes being exchanged and their corresponding DICOM-RT Tag can be found below:

Attribute Name	Tag
Patient's Name	(0010,0010)
Patient ID	(0010,0020)
Study Instance UID	(0020,000D)
Study ID	(0020,0010)
Study Description	(0008,1030)

Table 7 Patient/Study Info

Attribute Name	Tag
RT Plan Label	(300A,0002)
RT Plan Name	(300A,0003)
TreatmentSites	(300A,000B)
SOP Instance UID	(0020,000D)
Referenced Structure Set Sequence / Item / Referenced SOP Instance UID	(300C,0060) (FFFE,E000) (0008,1155)
Beam Sequence / Item	(300A,00B0) (FFFE,E000)
Fraction Group Sequence / Item / Referenced Beam Sequence / Item	(300A,0070) (FFFE,E000) (300C,0004) (FFFE,E000)
Dose Reference Sequence / Item	(300A,0010) (FFFE,E000)

Table 8 RTPLAN

Attribute Name	Tag
Beam Name	(300A,00C2)
Beam Number	(300A,00C0)
Treatment Delivery Type	(300A,00CE)
Number Of Fractions Planned	(300A,0078)
Control Point Sequence / Item	(300A,0111) (FFFE,E000)

Table 9 Beam

Attribute Name	Tag
Isocenter Position	(300A,012C)
Gantry Angle	(300A,011E)
Gantry Rotation Direction	(300A,011F)
Nominal Beam Energy	(300A,0114)

Table 10 Control Point

Attribute Name	Tag
Beam Meterset	(300A,0086)
Referenced Beam Number	(300C,0006)

Table 11 Meterset

Attribute Name	Tag
Dose Reference Number	(300A,0012)
Dose Reference Structure Type	(300A,0014)
Dose Reference Description	(300A,0016)
Dose Reference Point Coordinates	(300A,0018)

Table 12 RT Prescription Module

Attribute Name	Tag
SOP Instance UID	(0020,000D)
Structure Set ROI Sequence/ Item	(3006,0020) (FFFE,E000)
ROI Contour Sequence / Item	(3006,0039) (FFFE,E000)

Table 13 RTSTRUCT

Attribute Name	Tag
ROI Name	(3006,0026)
ROI Number	(3006,0022)

Table 14 ROI

Attribute Name	Tag
Referenced ROI Number	(3006,0084)
Contour Sequence / Item	(3006,0040) (FFFE,E000)

Table 15 ROI Contour

Attribute Name	Tag
Contour Geometric Type	(3006,0042)
Number Of Contour Points	(3006,0046)
Contour Data	(3006,0050)

Table 16 The ROI contour sequence

## 2.6.2 Testing

The DICOM-RT workflow is tested end-to-end and the list of parameters are verified for each installation.

## 2.6.3 Time Synchronization

The network time protocol (NTP) can optionally be used for time synchronization over the same ethernet connection that the DICOM-RT interface is present on. If applicable, the Raypilot workstation can be added to the Microsoft Active Directory domain, time synchronization is then handled in conjunction with active directory.

---

## 2.6.4 Secure Configuration

This chapter describes a secure configuration that limits the potential impact of vulnerabilities.

### 2.6.4.1 *Virus and Threat Protection Settings*

Open Windows Security and navigate to the virus and threat protection manager. Make sure that the following are turned on:

- Real-time protection
- Cloud-delivered protection
- Automatic sample submission
- Tamper protection

#### **Controlled Folder Access**

Open the manager for controlled folder access and add the folder:

“C:\Users\[User]\AppData\Roaming\Micropos Medical AB”

Allow both “Raypilot.exe” and “Raypilot Configuration Manager.exe” to access the folder.

#### **Notifications**

Make sure that notifications are turned on:

- Virus and threat protection notifications
- Account protection notifications
- Firewall and network protection notifications

### 2.6.4.2 *Device Security*

Activate “Memory Integrity” under “Device Security” > “Core Isolation”.

### 2.6.4.3 *Firewall and Network Protection*

Turn on the Windows defender firewall for the following networks:

- Domain network
- Private network
- Public network

### 2.6.4.4 *Internet Protocol Security (IPSec) Configuration*

When the Microsoft SQL Server is deployed in a Raypilot multiroom setup the communication between the Raypilot computer(s) and the SQL Server is authenticated and encrypted using IPSec.

#### **IPSec Settings for the SQL Server**

On the SQL Server computer, open the settings for Windows Firewall with Advanced Security. After that you need to create two rules for the firewall. First the inbound rule, which allows the clients to connect to your server. And secondly a security rule, in which you define how the connections are authenticated and secured.

---

### **Firewall Inbound Rule**

Right-click Inbound Rules and choose New Rule. You will be guided through the following steps:

- Rule Type
- Program
- Protocol and Ports
- Scope
- Action
- Profile
- Name

#### Rule Type

Select the “Custom” rule type and click Next.

#### Program

In this program dialog choose All programs and click Next.

#### Protocol and Ports

For SQL Server that's running on the default port, we'll choose TCP and Specific Port 1433 as the Local port. Leave Remote Ports to its default setting (All Ports), meaning that connection from any port to 1433 will be affected by this rule. Click Next again.

#### Scope

Set both local and remote IP addresses to the default setting (Any IP address) and click Next.

#### Action

Select “Allow the connection if it is secure” and click “Customize”. Select “Require the connection to be encrypted” and check “Allow the computers to dynamically negotiate encryption”. Click OK and then Next.

#### Profile

In the Profile dialog, choose all three, Domain, Private and Public. Click Next.

#### Name

Name the inbound rule “Connection rule – inbound SQL Server traffic”. Add the description “This is the rule for incoming connections to SQL Server [TCP 1433].” Click Finish.

### **Connection Security Rule**

Right-click Connection Security Rules and choose New Rule. A guide will go through the following steps:

- Rule Type
- Endpoints
- Requirements
- Authentication Method
- Protocol and Ports

- 
- Profile
  - Name

#### Rule Type

Select the “Custom” rule type and click Next.

#### Endpoints

Set both Endpoint 1 and Endpoint 2 to the default setting (Any IP address) and click Next.

#### Requirements

Select “Require authentication for inbound and outbound connections” and click Next.

#### Authentication Method

Select “Computer (Kerberos V5)” and click Next.

#### Protocol and Ports

Select TCP as Protocol type and Specific Ports 1433 for Endpoint 1. Select All Ports for Endpoint 2.

#### Profile

In the Profile dialog, choose all three, Domain, Private and Public. Click Next.

#### Name

Name the connection security rule “Connection security rule – inbound SQL Server traffic”. Add the description “This is the connection security rule for incoming connections to SQL Server [TCP 1433].” Click Finish.

### **IPSec settings for the Raypilot Workstation(s)**

On the Raypilot workstation, open the settings for Windows Firewall with Advanced Security. After that you need to create two rules for your firewall. First the outbound rule. And secondly a security rule.

#### ***Firewall Outbound Rule***

Right-click Outbound Rules and choose New Rule. A guide will go through the following steps:

- Rule Type
- Program
- Protocol and Ports
- Scope
- Action
- Profile
- Name

#### Rule Type

Select the “Custom” rule type and click Next.

---

### Program

In this program dialog choose All programs and click Next.

### Protocol and Ports

Select TCP as protocol type and leave the Local port to its default setting (All Ports). Set the Remote port to Specific Port 1433. Click Next again.

### Scope

Set both local and remote IP addresses to the default setting (Any IP address) and click Next.

### Action

Select "Allow the connection if it is secure" and click "Customize". Select "Require the connection to be encrypted" and check "Allow the computers to dynamically negotiate encryption". Click OK and then Next.

### Computer

At the Computers dialog, leave them empty and then click Next.

### Profile

In the Profile dialog, choose all three, Domain, Private and Public. Click Next.

### Name

Name the outbound rule "SQL Server Connections- outbound rule". Add the description "This is the rule used by clients when connecting to SQL Server [TCP 1433]." Click Finish.

### **Connection Security Rule**

Right-click Connection Security Rules and choose New Rule. You will be guided through the following steps:

- Rule Type
- Endpoints
- Requirements
- Authentication Method
- Protocol and Ports
- Profile
- Name

### Rule Type

Select the "Custom" rule type and click Next.

### Endpoints

Set both Endpoint 1 and Endpoint 2 to the default setting (Any IP address) and click Next.

### Requirements

Select "Require authentication for inbound and outbound connections" and click Next.

### Authentication Method

Select "Computer (Kerberos V5)" and click Next.

---

---

### Protocol and Ports

Select TCP as Protocol type and All Ports for Endpoint 1. Select Specific Ports 1433 for Endpoint 2.

### Profile

In the Profile dialog, choose all three, Domain, Private and Public. Click Next.

### Name

Name the connection security rule "Connection security rule – outbound SQL Server traffic". Add the description "This is the connection security rule for outgoing traffic to SQL Server [TCP 1433]." Click Finish.

### Safety

There are no hazardous situations resulting from a failure to transfer DICOM-RT information to the Raypilot System. The worst case of a connection failure will result in the clinic having to enter data entries manual, the patient data, and the treatment planning data. Inaccurately entered data will not affect the quality of the treatment or the treatment outcome for the patient.

The responsible organization (the clinic) should, where the DICOM-RT interface is intended to connect to the clinic's IT network, be aware that:

## **2.7 Safety**

There are no hazardous situations resulting from a failure to transfer DICOM-RT information to the Raypilot System. The worst case of a connection failure will result in the clinic having to enter data entries manual, the patient data, and the treatment planning data. Inaccurately entered data will not affect the quality of the treatment or the treatment outcome for the patient.

The responsible organization (the clinic) should, where the DICOM-RT interface is intended to connect to the clinic's IT network, be aware that:

- Connection of the DICOM-RT interface to an IT network that includes other equipment could result in previously unidentified risks to patients, users or third parties.
- The responsible organization (the clinic) should identify, analyse, evaluate and control these risks.
- Subsequent changes to the IT network could introduce new risks and require additional analysis. And:  
Changes to the IT network include:
  - changes in the IT network configuration.
  - connection of additional items to the IT network.
  - disconnecting items from the IT network.
  - update of equipment connected to the IT network; and
  - upgrade of equipment connected to the IT network.

---

## 3 Safety

The Raypilot System does not have any residual risks. Warnings and cautions are from product standards and conclusions by Micropos Medical during risk evaluation.

All Raypilot System components and accessories shall be handled with care.

### 3.1 Target Group

The target group for this information are medical physicists, radiation oncologists, and radiation technologists who work with radiation treatment of cancer patients.

### 3.2 Installation and Service

Installation, service, maintenance and repairs of the Raypilot System must be conducted by Micropos Medical personnel or service personnel authorized by Micropos Medical.

The installation shall be performed so that mains plug is easy accessible.

The Raypilot Power Box shall be installed and connected to an outlet with protective earth (100-240 VAC and 50/60 Hz). The power supply shall be installed far away from the treatment table.

Please consult with Micropos Medical regarding any changes to the use environment (e.g., replacing the linear accelerator, treatment couch, room lasers, etc.) that may prevent the Raypilot System from passing the Quality Control.

### 3.3 Educational Requirements

The safety instructions in the relevant manuals require that personnel operating Micropos Medical products have the necessary education and training. Micropos Medical provides adequate training for the Raypilot System.

A good understanding of the language that the information is presented in is required, to make sure that these and other instructions can be understood and complied with.

---

## 3.4 Warnings

---



### **Warning!**

Make sure that the system is connected to supply mains with protective earth. This will help prevent an electric shock. An electric shock can cause injury to personnel and/or damage to the equipment.

---

---



### **Warning!**

Do not modify or open the products. This can cause injury to personnel and/or damage to the equipment.

---

---



### **Warning!**

Use of accessories, transducers and cables other than those specified or provided by the manufacturer of this equipment could result in increased electromagnetic emissions or reduced electromagnetic immunity of this equipment and result in improper operation. This can cause injury to personnel and/or damage to the equipment.

---

---



### **Warning!**

Use of this equipment adjacent to or stacked with other equipment should be avoided because it could result in improper operation. If such use is necessary, this equipment and the other equipment should be observed to verify that they are operating normally or it can cause injury to personnel and/or damage to the equipment.

---

---



### **Warning!**

Portable RF communications equipment (including peripherals such as antenna cables and external antennas) should be used no closer than 30 cm (12 inches) to any part of the receiver, including cables specified by the manufacturer. Otherwise, degradation of the performance of this equipment could result. This will help prevent injury to personnel and/or damage to the equipment.

---

---

## 3.5 Cautions

---



### Caution!

Make sure that the cables are lying unimpeded outside the irradiation field, and ensure that the couch and gantry can be moved freely. This will help prevent damage to the equipment.

---



### Caution!

Make sure that radiation does not occur in area beyond line: "No radiation beyond this line" (that is written on top of the Raypilot Receiver). Radiation beyond that may effect the Raypilot Receiver System Electronics and cause damage to the equipment.

---



### Caution!

Make sure that the correct transmitter, couch displacement, and patient data is inserted into the system so that correct patient setup data can be loaded and verified according to clinical routine.

---



### Caution!

Make sure that the correct transmitter offset to isocentre is used throughout the course of treatment, in order to have a correct patient setup guidance.













---

## 3.6 Contraindication

Do not use the Raypilot System on patients that weigh more than 135 kg.

## 3.7 Symbols on the Products

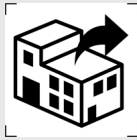
Symbol	Description
	<b>Operating instructions</b> Consult instructions for use
	<b>Protective earth (ground)</b>
	<b>TYPE BF APPLIED PART</b> To identify a type BF applied part complying with IEC 60601-1 NOTE 1 - B = Body NOTE 2 - F = Floating applied part

Symbol	Description
	<b>Non-ionizing electromagnetic radiation</b> To indicate generally elevated, potentially hazardous, levels of non-ionizing radiation, or to indicate equipment or systems e.g. in the medical electrical area that include RF transmitters or that intentionally apply RF electromagnetic energy for diagnosis or treatment
	<b>Date of manufacture</b>
	<b>Manufacturer</b>
	<b>Serial number of device</b>
	<b>Item number of device</b>
	<b>Disposal of the Raypilot System and its parts shall be done according to the Waste Electrical and Electronic Equipment (WEEE) Directive.</b>
	<b>Prescription use only (term applicable in US).</b>
	<b>Unique device identifier</b>
	<b>Translation performed by Semantix: Adress: Box 10059, 100 55 Stockholm, Sweden</b>
	<b>Country of manufacture. If date adjacent to symbol, it signifies date of manufacture.</b>
	<b>Distributor.</b>
	<b>Importer.</b>

Symbol	Description
	Medical device.

### 3.8 MR Unsafe



Figure 7 MR unsafe symbol

The Raypilot Hypocath is MR unsafe. Keep it outside the MRI scanner room.

### 3.9 Treatment Duration and Patient Sensitization

If the patient treatment for any reason is prolonged to more than 30 days, the Raypilot Hypocath needs to be replaced.

The Raypilot Matching Network contains nickel. If a patient has a known sensitization to nickel or shows symptoms of skin irritation on the leg, use a paper or gauge to avoid direct skin contact with the Raypilot Matching Network.





### 3.10 Security

This chapter contains instructions on how to keep the Raypilot Software secure.

Do not under any circumstances perform any of the following without consulting with Micropo Medical:





- Install any software on the Raypilot workstation.
- Deactivate Microsoft Defender Antivirus\*.
- Deactivate Microsoft Defender Firewall\*\*.
- Modify the hardware configuration.
- Modify the Raypilot Software configuration.

If Microsoft Defender Antivirus has detected malware on the Raypilot workstation, the user will receive a message in Windows Security. We recommend the user to run a Microsoft Defender Offline Scan by performing the following steps:

1. Disconnect the Raypilot workstation from the network.
2. Select Start , and then select Settings  > Update & Security  > Windows Security  > Virus & threat protection .

3. On the Virus & threat protection screen, under Current threats, select Scan options.
4. Select Microsoft Defender Offline Scan, and then select Scan now.

When the scan has completed, the user can access the results by performing the following steps:

1. Select Start , and then select Settings  > Update & Security  > Windows Security  > Virus & threat protection .
2. On the Virus & threat protection screen in Windows 10, under Current threats, select Scan options, and then select Protection history.

The scan results must be communicated with Micropos Medical to assess if the Raypilot System can be reinstated into clinical use again.

\* Microsoft Defender Antivirus is a component of Microsoft Windows that delivers real-time protection against software threats like viruses, malware, and spyware.

\*\* Microsoft Defender Firewall is a program that protects against threats that can enter the workstation over the network.

### 3.11 Indexing the Raypilot Receiver

Use indexing bars to index the Raypilot Receiver on the treatment couch of the linear accelerator. If indexing is not fulfilled the Raypilot System will not perform as intended.

### 3.12 Environmental Conditions

Please contact Micropos Medical if environmental conditions are not met. The Measurement Quality indicator will display red, and the system will not perform as intended.

#### Environmental conditions:

The environmental conditions are only relevant for use and storage since the system is released and tested after transport.

Temperature:	The device is considered safe at a temperature, +10°C to +40°C.
Humidity:	The Raypilot System is considered safe at a relative humidity level of 30% to 75%.
Pressure:	The device is considered safe at an atmospheric pressure range of 70.0 kPa to 106.0 kPa.

#### Note!

Raypilot Hypocath is classified as IP57.

### 3.13 Packaging Damage

Please contact Micropos Medical if the packaging of the Raypilot System is damaged or unintentionally opened before installation.

### 3.14 Serious Incident Reporting

To report any patient incident when using the device please contact Micropos Medical at:

---

support@micropos.se

If the incident is regarded a serious incident according to MDR 2017/745 it has also to be reported to the competent authority in your country.

If empty not applicable



# 4 Settings

## 4.1 Sign In Raypilot Software

### 4.1.1 Description

#### Task

The task is to log in on Raypilot Software.

#### Task interval

Pre-treatment.

#### Conditions

User account has been created.

### 4.1.2 Instructions

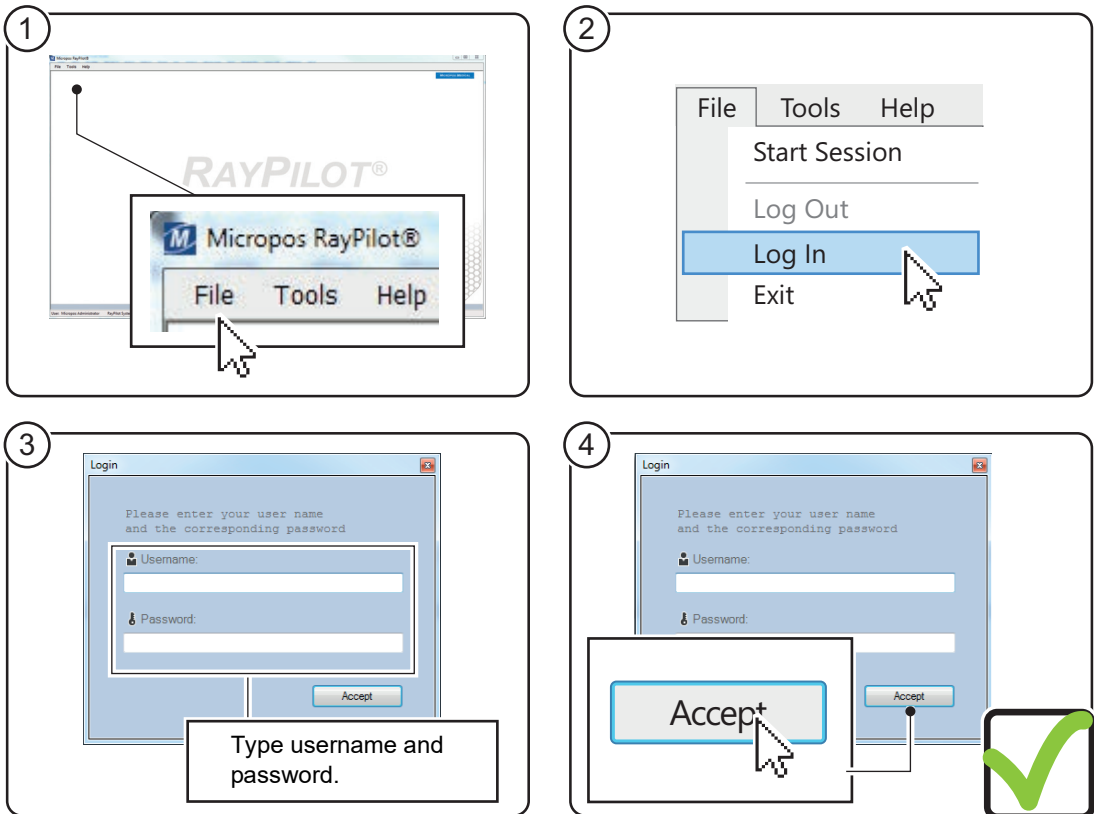

Figure 8 Sign-In instructions

---

## 4.2 Administrator's Function

### 4.2.1 Description

#### Task

The task is to use various administrator functions.

#### Task interval

Pre-treatment.

#### Conditions

User is signed in to Raypilot Software, see 4.1 Sign In Raypilot Software.

User has administrator permission level. For more information, see 1.10.3 Software Access.

## 4.2.2 Add New User

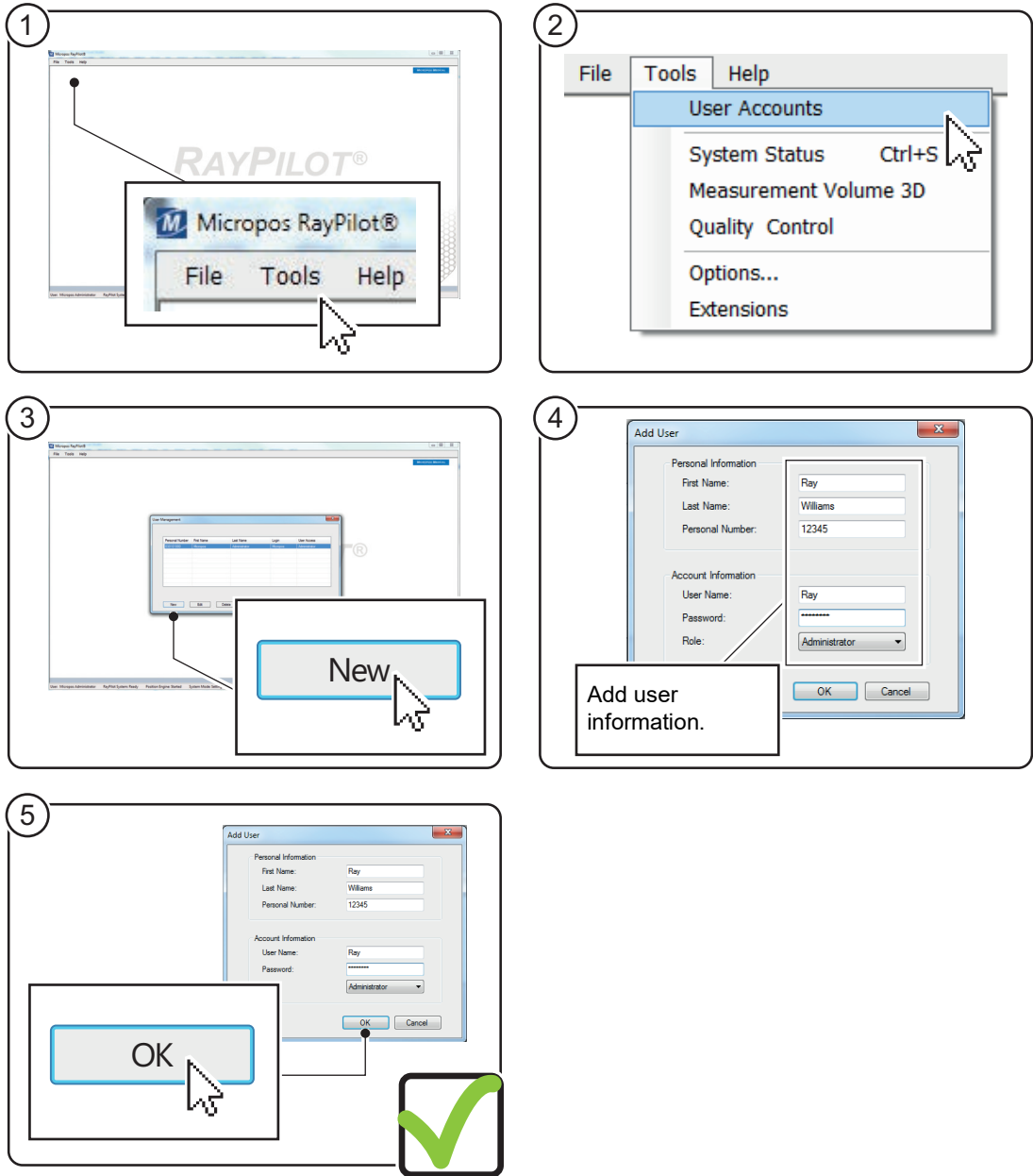

Figure 9 Instructions for adding new user

### 4.2.3 Edit User

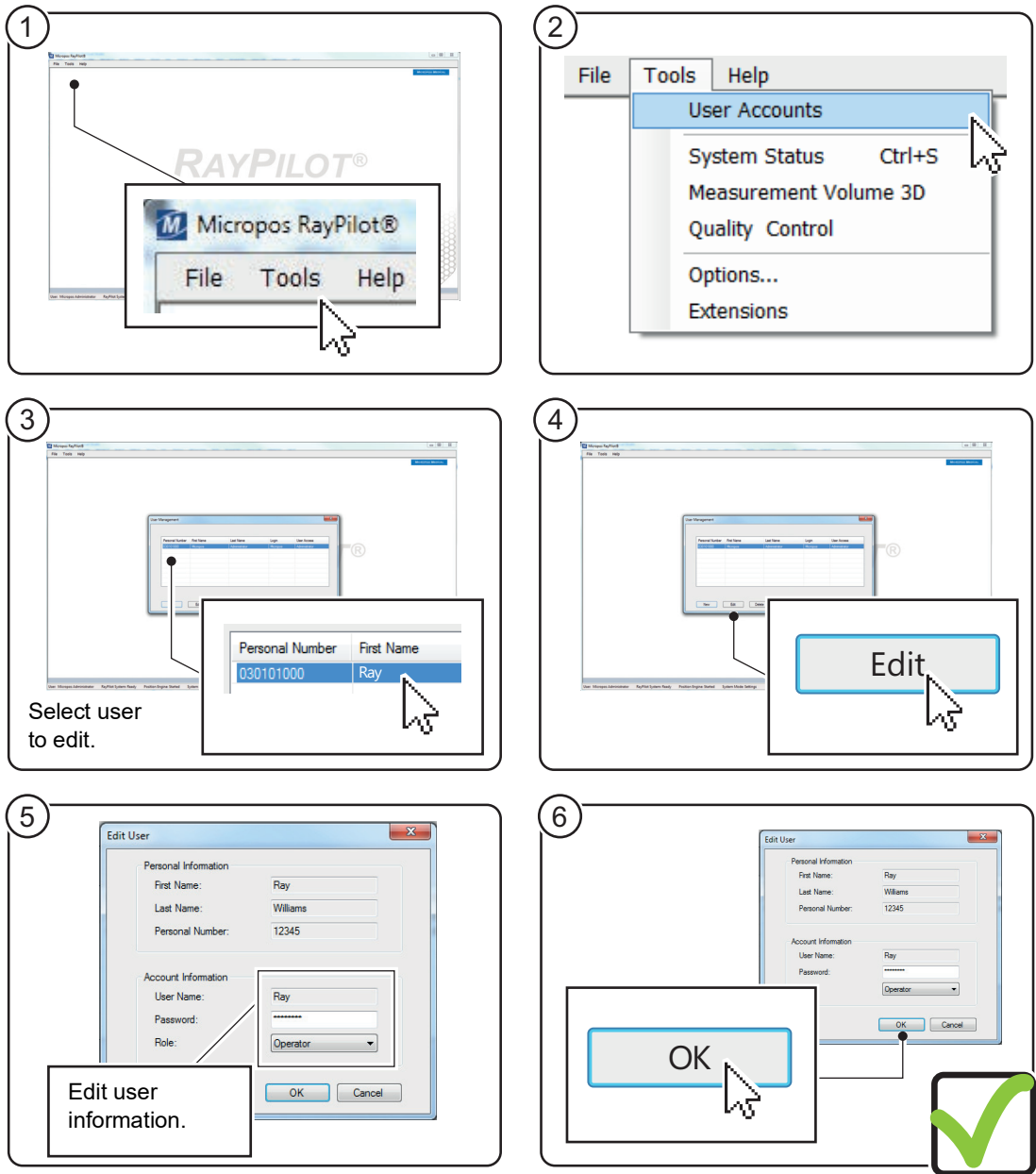

Figure 10 Instructions for editing user

#### 4.2.4 Delete User

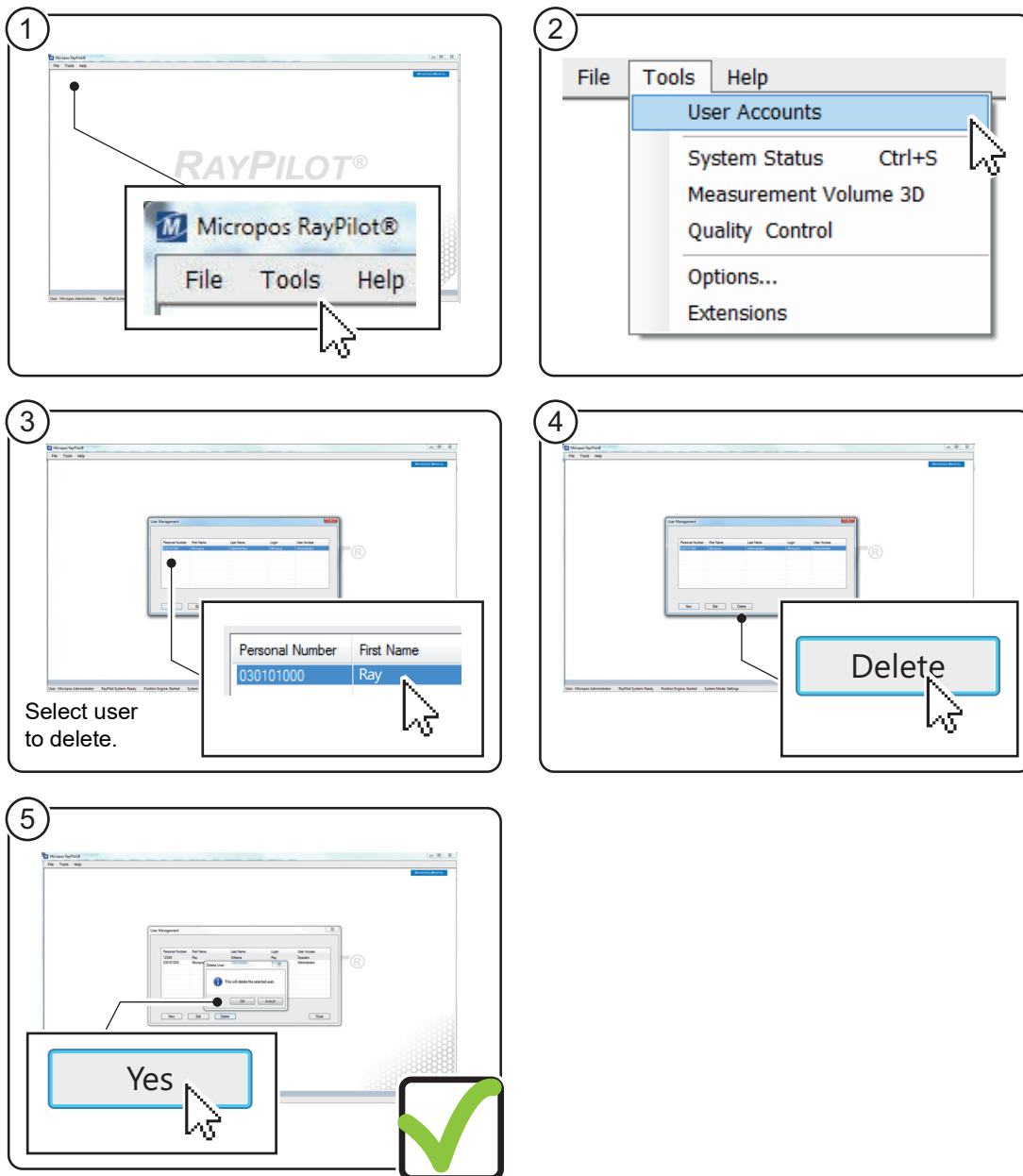

Figure 11 Instructions for deleting user

---

## 4.3 Operator's Function

### 4.3.1 Description

#### Task

The task is to use various operator's functions.

#### Task interval

Pre-treatment.

#### Conditions

User is signed in to Raypilot Software, see 4.1 Sign In Raypilot Software.

### 4.3.2 Add New Patient from DICOM-RT Database

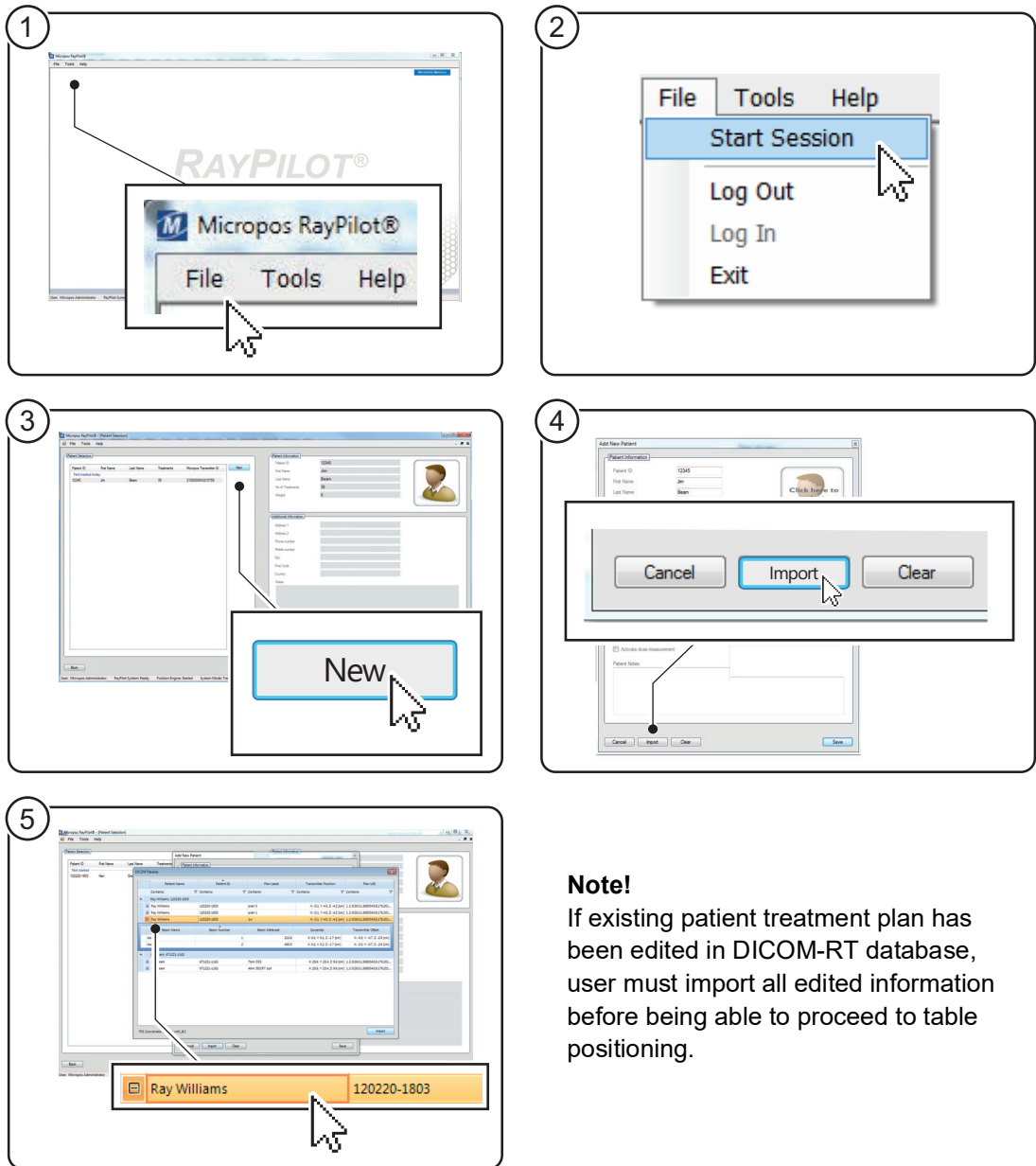

Figure 12 Instructions for adding new patient from DICOM – RT database (step 1-5)

**Note!**

If new patient treatment plan has been created in DICOM-RT database, user can choose between adding new treatment plan or proceed with old treatment plan.

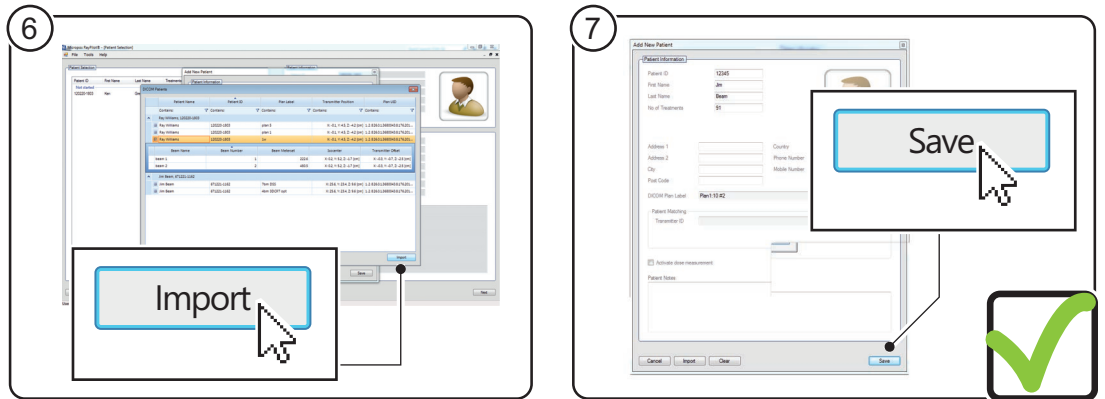

Figure 13 Instructions for adding new patient from DICOM – RT database (step 6-7)

### 4.3.3 Add New Patient without DICOM-RT Database

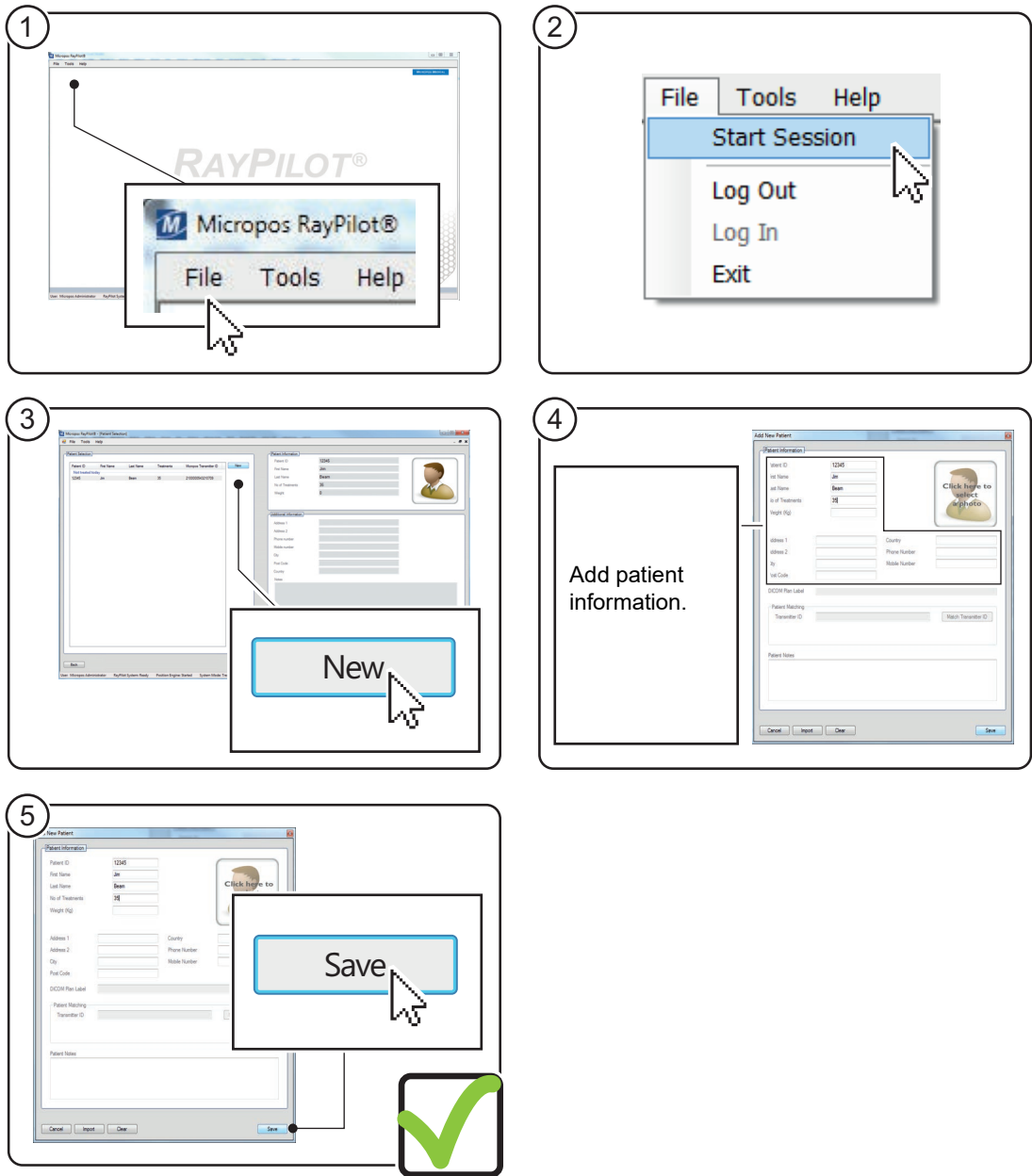

Figure 14 Instructions for adding new patient without data from DICOM – RT database

### 4.3.4 Edit Patient Information

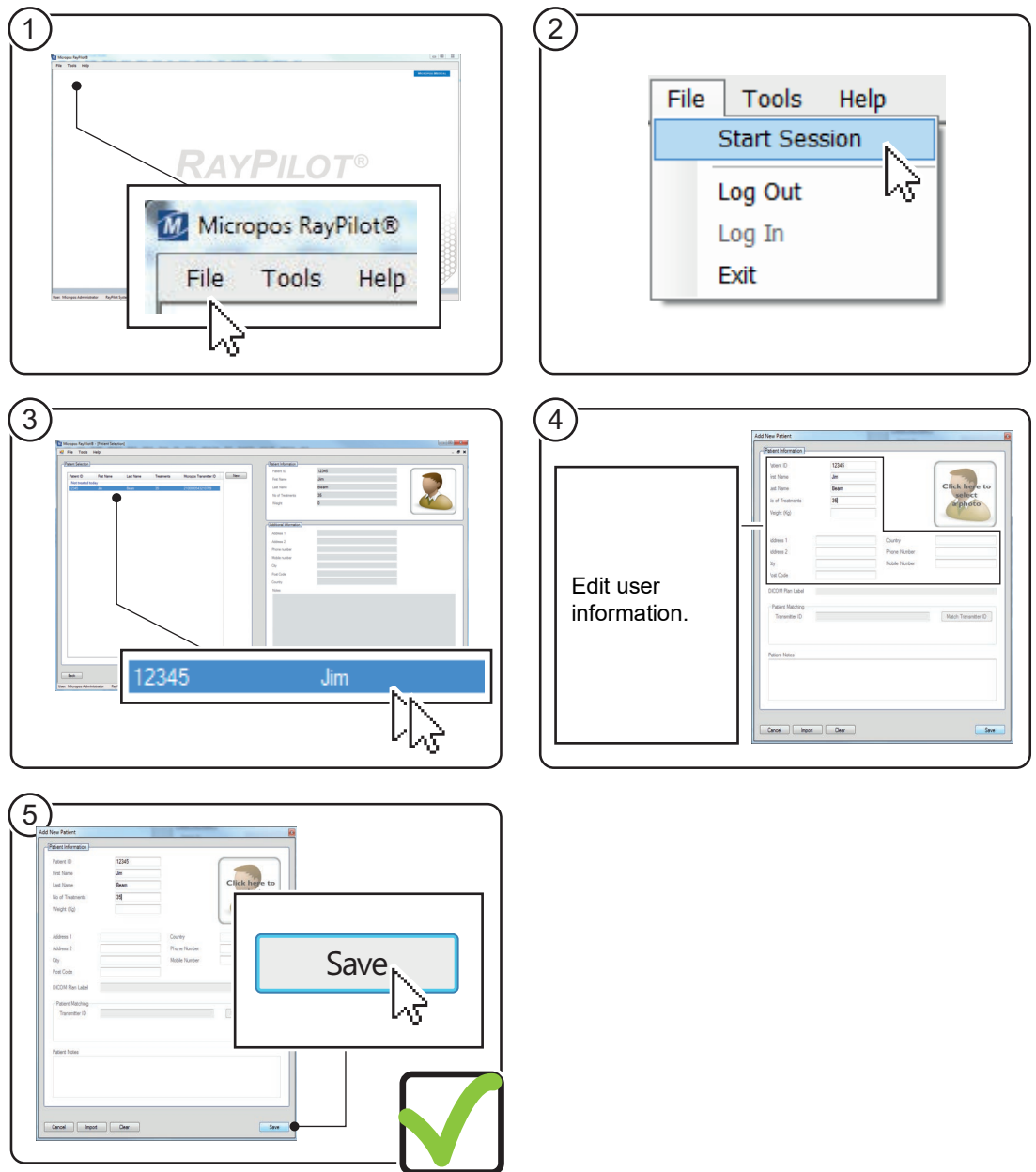

Figure 15 Instructions for editing patient information

### 4.3.5 Review Patient Records

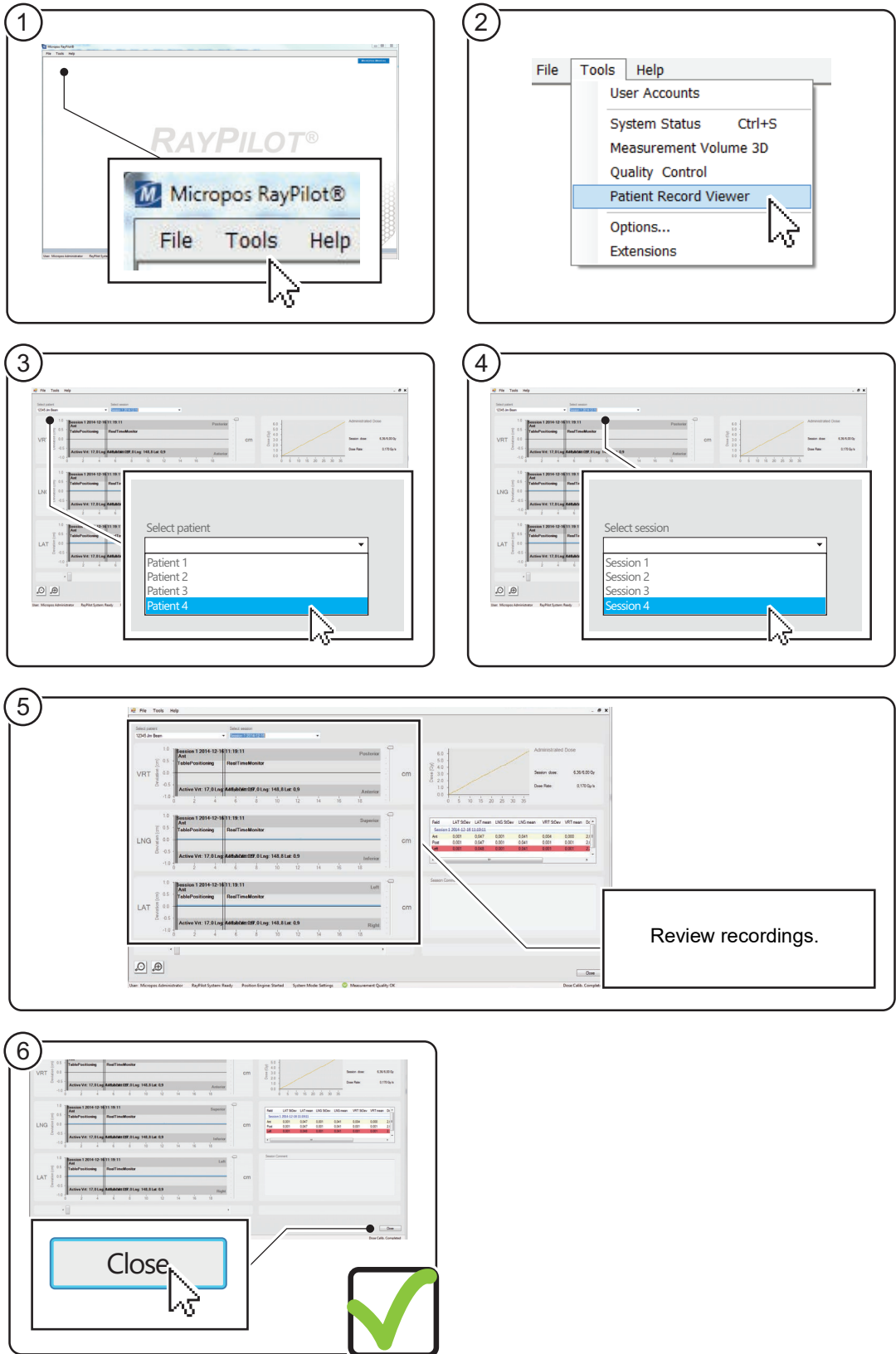

Figure 16 Instructions for reviewing patient records



---

# 5 Treatment

## 5.1 Set Up Equipment

### 5.1.1 Description

#### Task

The task is to set up Raypilot Receiver.

#### Task interval

Pre-treatment.

#### Conditions

Raypilot Receiver has been calibrated during first installation by Micropos Medical representative.

2 Index bars.

## 5.1.2 Instructions

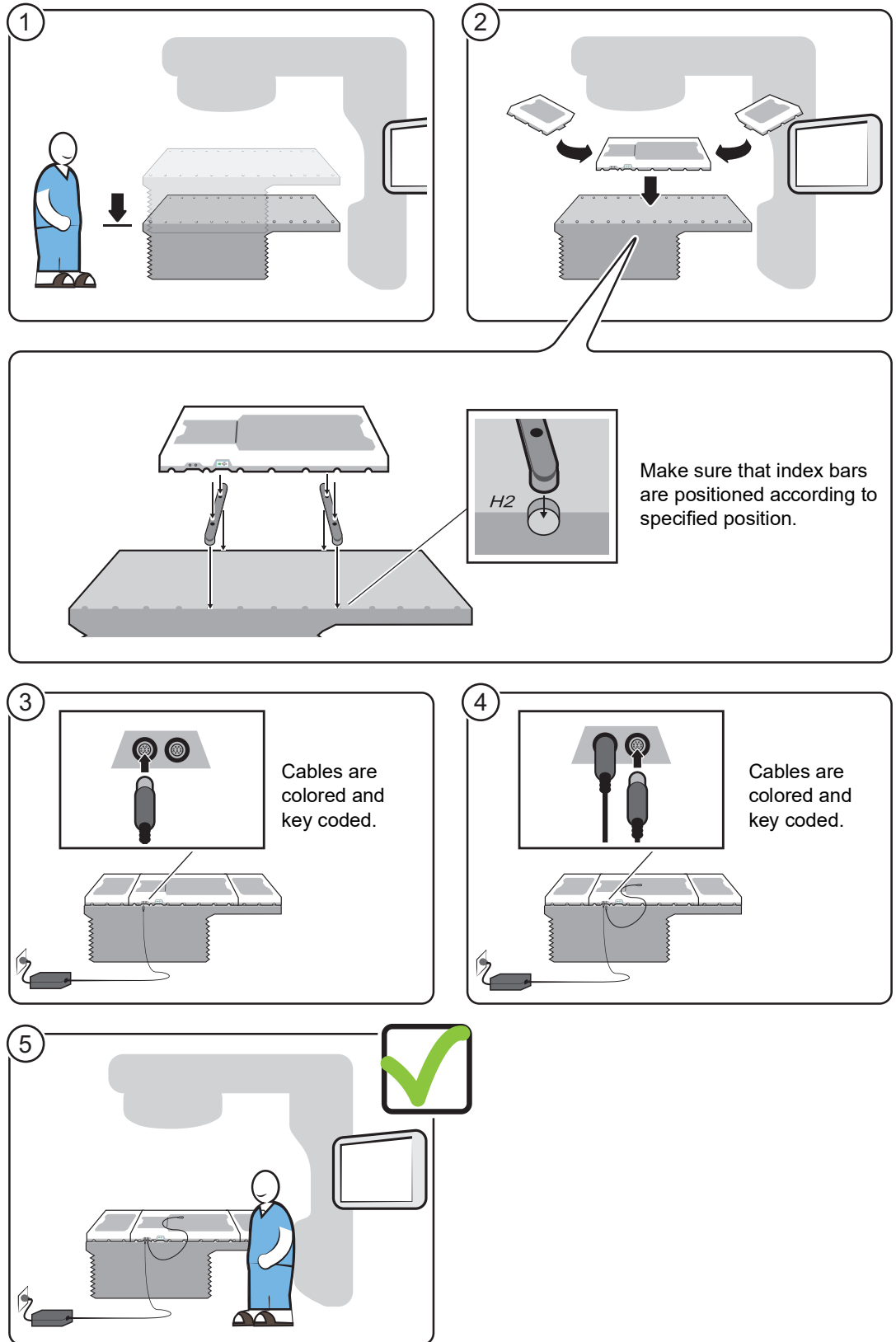

Figure 17 Instructions for setting up equipment

---

## 5.2 Daily Quality Control

Using the Raypilot Quality Control Kit, the performance of the Raypilot System is ensured by comparing the position of the transmitter recorded during installation to the current position recorded during the Quality Control. Performance is considered acceptable if the Measurement Quality is OK (green) and that the radial distance between the two positions is less than 0.2 centimeters. The Raypilot System will not be operational if the Quality Control fails.

### 5.2.1 Description

#### Task

The task is to verify Raypilot Receiver System functions.

#### Task interval

Pre-treatment.

#### Conditions

Raypilot Accessories are needed for this task, see 1.7 Illustrations of Raypilot Accessories.

Equipment is set up, see 5.1 Set Up Equipment.

User is signed in to Raypilot Software, see 4.1 Sign In Raypilot Software.

## 5.2.2 Instructions

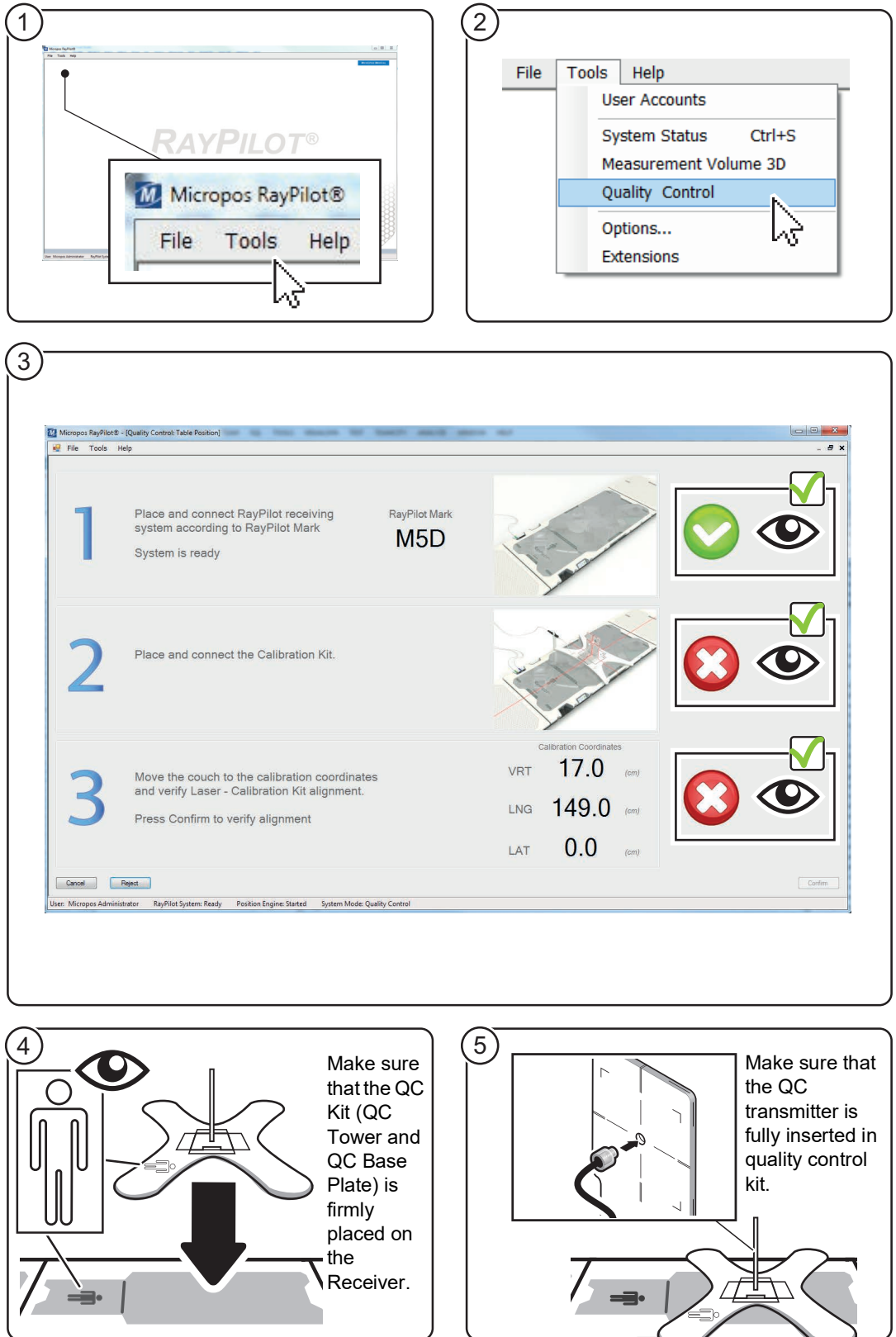

Figure 18 Instructions for daily quality control (step 1-5)

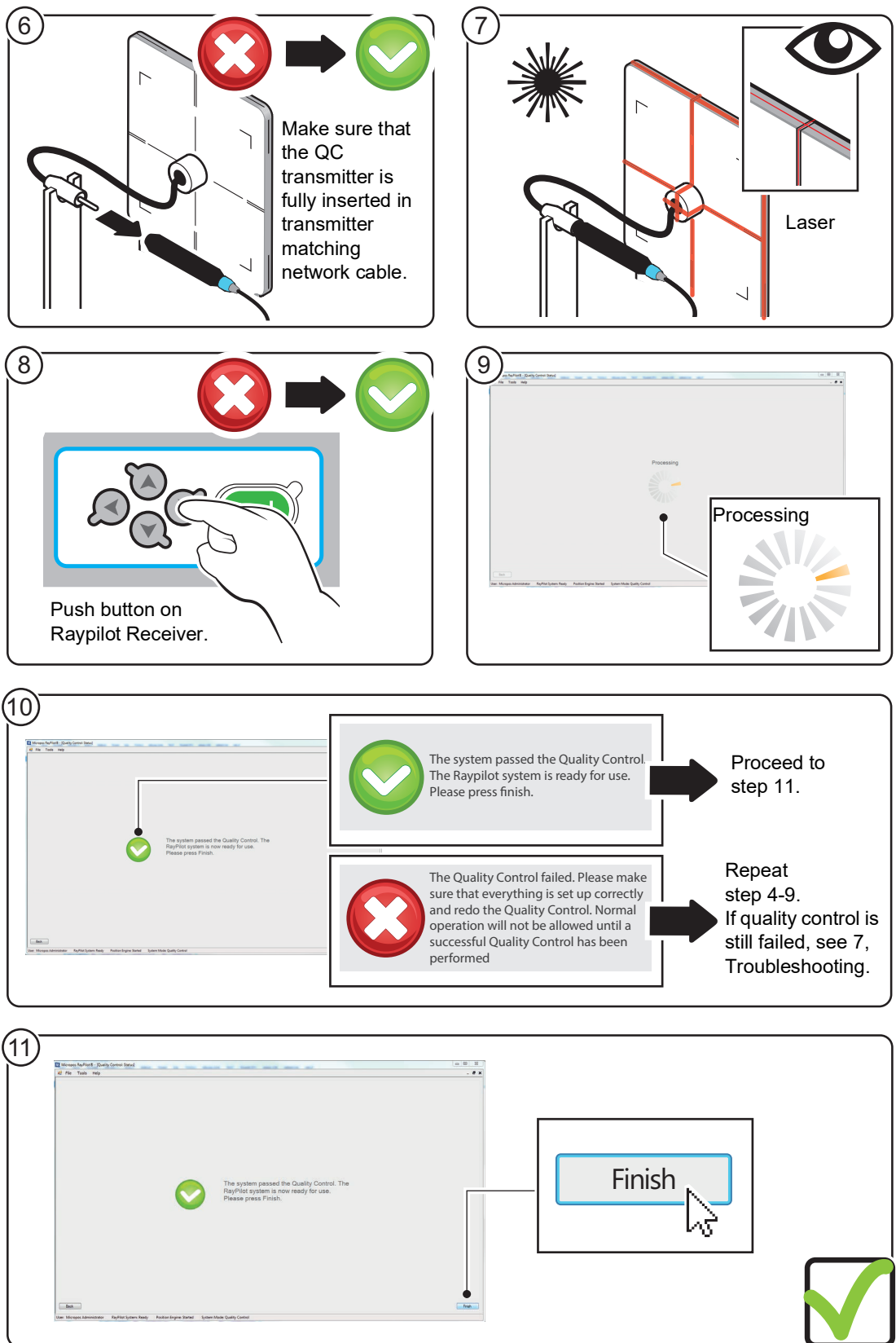

Figure 19 Instructions for daily quality control (step 6-11)

---

## 5.3 Add Patient Transmitter Displacement

### 5.3.1 CT Scan

Before treatment, the patient will undergo a CT scan for treatment planning. The Raypilot Hypocath or the Raypilot Viewcath must be inserted before this CT scan.

#### Note!

The thickness of the CT scans affects the accuracy in determining the position of the transmitter tip in relation to the isocentre during the treatment.

### 5.3.2 Transmitter Displacement

When the Raypilot Hypocath (or Raypilot Viewcath) is inserted into the prostatic urethra, the position of the transmitter tip (or the marker), in relation to the isocentre, is called transmitter displacement. Identify the coordinate of the transmitter tip or the marker in the images, and add the position to the dose plan. It can then be imported automatically with the plan. The transmitter displacement can also be inserted manually in the Raypilot Software. The position to mark in each direction (LAT, LNG, VRT) is the center of the transmitter tip or the marker. The position shall be named as “RP transmitter”.



Figure 20 Sketch of Raypilot Hypocath

The position can be marked in the treatment planning system using one of the following methods:

- **Create a point of interest**  
The user can digitize a point of interest (used in, for example, dose planning systems Oncentra, RayStation and Pinnacle). The point is stored in the RT structure set.
- **Create a dose reference point**  
The user can digitize a dose reference point that will be imported in the Raypilot Software as transmitter position (used in, for example, the dose planning system Eclipse). The point is stored in the RT plan.
- **Create a contour shape**  
The user can digitize the point with the use of small contours, creating a Region of interest (used in, for example, dose planning system Monaco). When creating the contour a brush (or some predefined contour shape) can be used. The best practice to position the contour is to zoom in as much as practical (typically to create a structure of 1 mm, the placement of the contour is much more precise in this way). Raypilot Software uses the calculated contours' centre points (centre of mass) and uses them for the position.

---

The transmitter stability in the target throughout the course of treatment influences the transmitter displacement. Make sure the Raypilot Hypocath is retracted until feeling resistance against the bladder wall, and fixed according to clinical procedure at the urethra opening.

**Note!**

If the offset is not taken from the CT image set and marked in the treatment planning step in the first treatment, see 5.7.4 Patient Set Up Guidance with Image Synchronization.

**5.3.3 Description**

**Task**

The task is to add transmitter displacement.

**Task interval**

Pre-treatment.

**Conditions**

Equipment is set up, see 5.1 Set Up Equipment.

User is signed in to Raypilot Software, see 4.1 Sign In Raypilot Software.

Patient added to database, see 4.3.2 Add New Patient from DICOM-RT Database.

### 5.3.4 Instructions

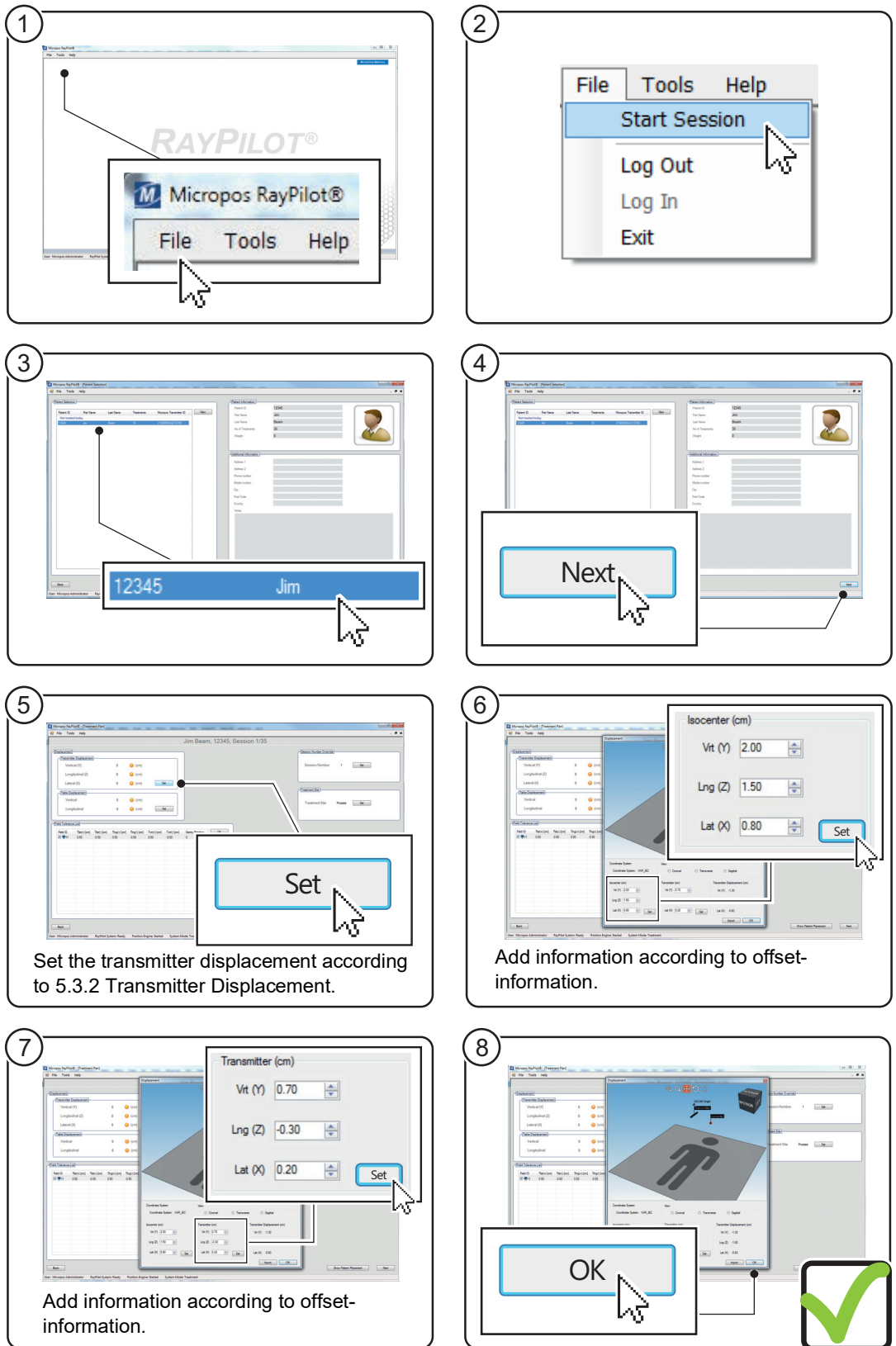

Figure 21 Instructions for adding patient transmitter displacement

---

## 5.4 Add Field Tolerance Parameters

### 5.4.1 Tolerance Parameters

Set tolerance parameters to make sure that the target is within the defined treatment volume. These tolerance parameters are called Left, Right, Superior, Inferior, Anterior and Posterior and specifies the thresholds along each axis. If the transmitter moves out of these tolerance parameters, a warning message will appear on the monitor.

Note that the tolerances are defined for each axis. When setting the tolerances the margins used in each direction should be taken into consideration, as well as the fact that motion could occur in several directions simultaneously.

The Planner select the parameters for each patient during treatment planning.

### 5.4.2 Description

#### Task

The task is to add field tolerance parameters.

#### Task interval

Pre-treatment.

#### Conditions

Equipment is set up, see 5.1 Set Up Equipment.

User is signed in to Raypilot Software, see 4.1 Sign In Raypilot Software.

Patient added to database, see 4.3.2 Add New Patient from DICOM-RT Database

Transmitter displacement information has been added, see 5.3 Add Patient Transmitter Displacement.

### 5.4.3 Instructions

**1**

**2**

**3**

**4**

**5**

**6**

**7**

**8**

**Note!**  
Click on the OK-button to save field tolerance parameters as template.

Figure 22 Instructions for adding field tolerance parameters

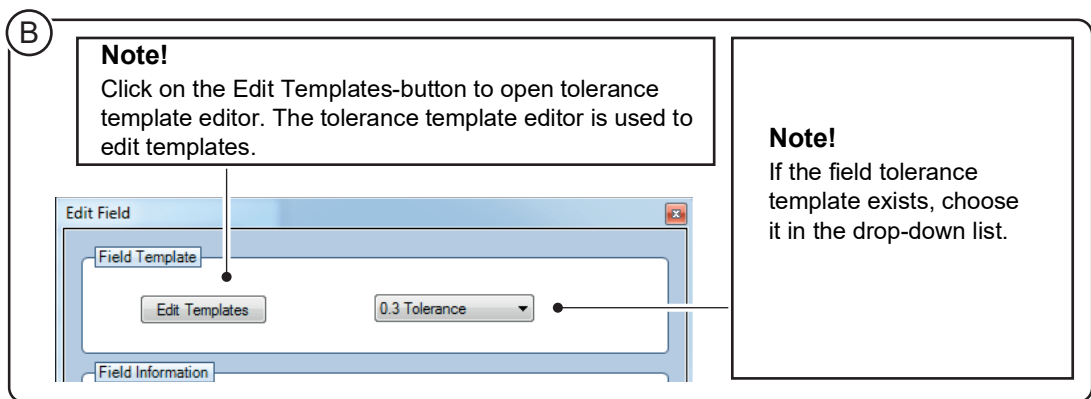
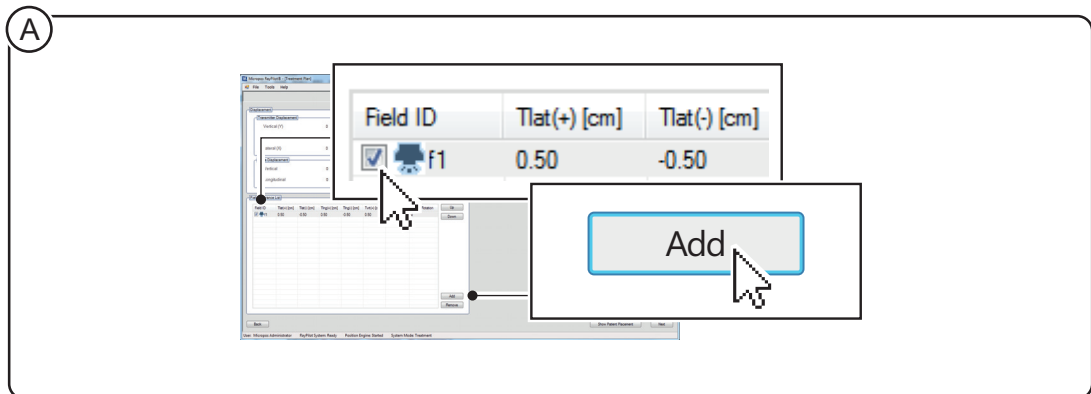

Figure 23 Notes for editing field tolerance parameters

## 5.5 Match Patient to Transmitter ID

### 5.5.1 Description

#### Task

The task is to match the patient to a transmitter ID.

#### Task interval

Pre-treatment.

#### Conditions

Equipment is set up, see 5.1 Set Up Equipment.

User is signed in to Raypilot Software, see 4.1 Sign In Raypilot Software.

Patient added to database, see 4.3.2 Add New Patient from DICOM-RT Database.

Patient with inserted Raypilot Hypocath, see Raypilot Hypocath instructions for use.

### 5.5.2 Match Transmitter ID in Control Room

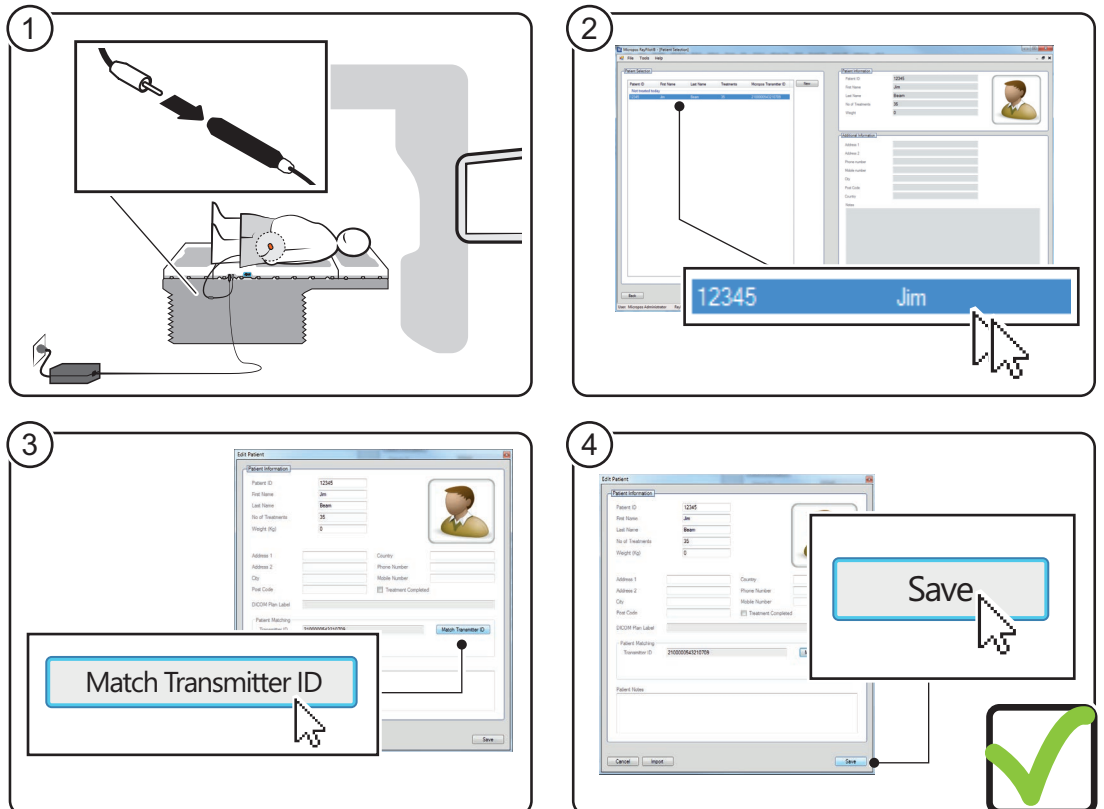

Figure 24 Instructions for matching transmitter ID in control room

### 5.5.3 Match Transmitter ID in Treatment Room

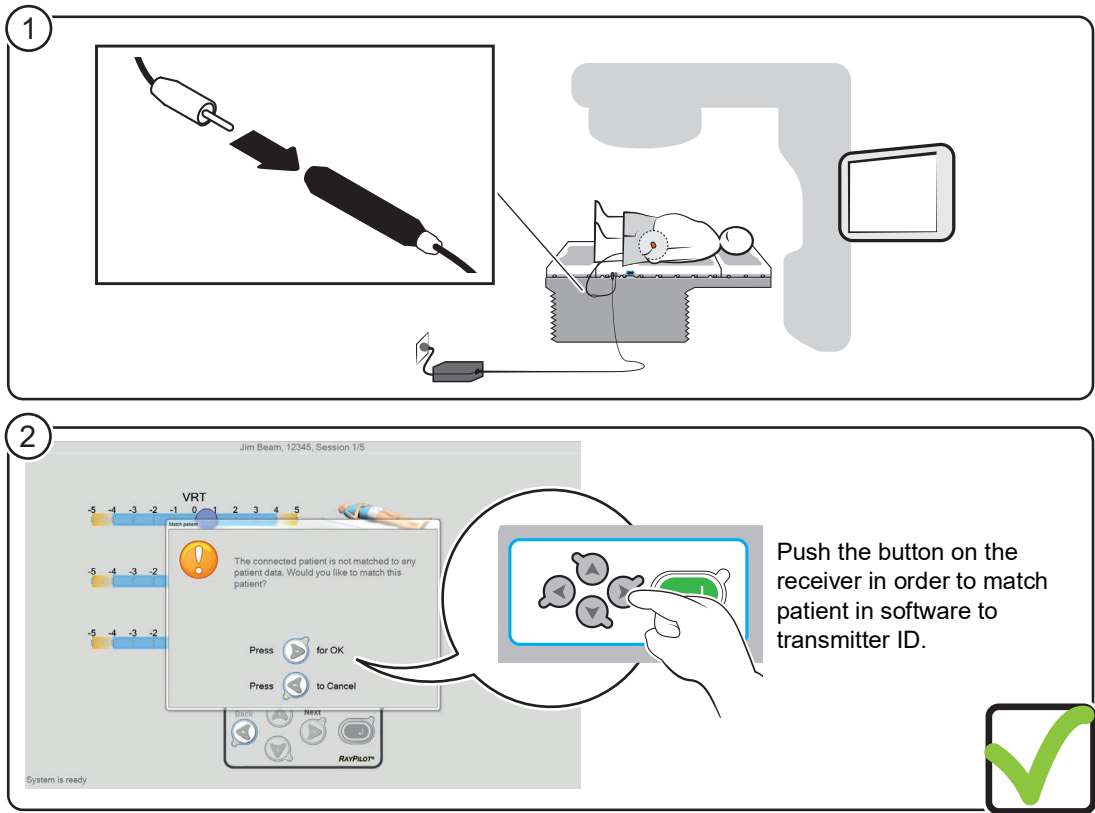

Figure 25 Instructions for matching transmitter ID in treatment room

---

## 5.6 First Treatment with Standard Table Positioning

### 5.6.1 Description

#### Note

In Step 5, make sure that the Raypilot Hypocath is connected all the way in.

In Step 5, make sure that the Raypilot Matching Network is not directly placed on the Receiver.

#### Task

The task is to perform patient treatment.

#### Task interval

During treatment.

#### Conditions

Equipment is set up, see 5.1 Set Up Equipment.

User is signed in to Raypilot Software, see 4.1 Sign In Raypilot Software.

Patient added to database, see 4.3.2 Add New Patient from DICOM-RT Database.

Daily control has been performed, see 5.2 Daily Quality Control.

Transmitter displacement information has been added, see 5.3 Add Patient Transmitter Displacement.

Field tolerance parameters has been added, see 5.4 Add Field Tolerance Parameters.

Transmitter ID and patient are matched, see 5.5 Match Patient to Transmitter ID.

## 5.6.2 Table Displacement and Patient Placement

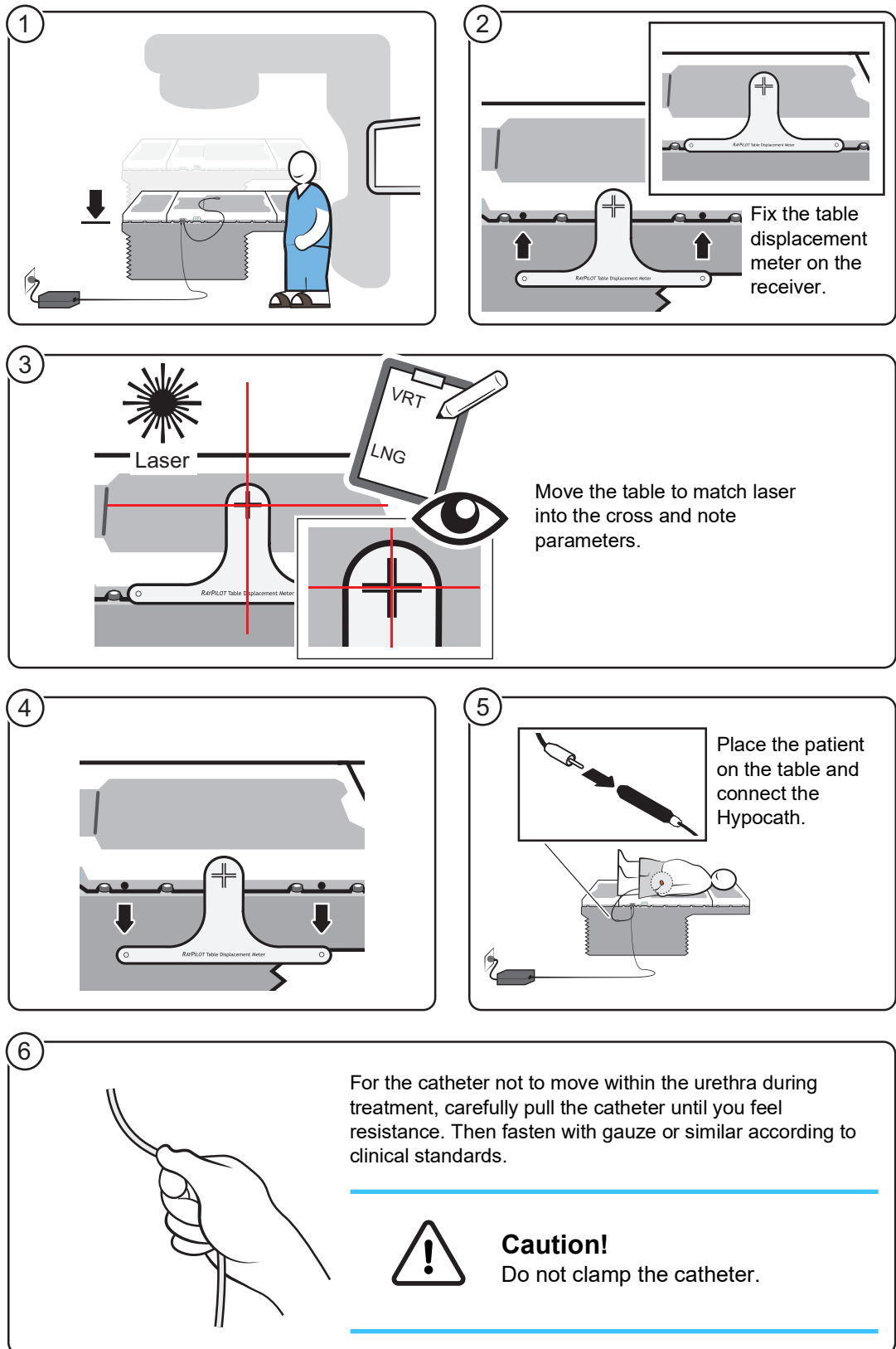

Figure 26 Instructions how to perform table displacement measurement (step 1-6)

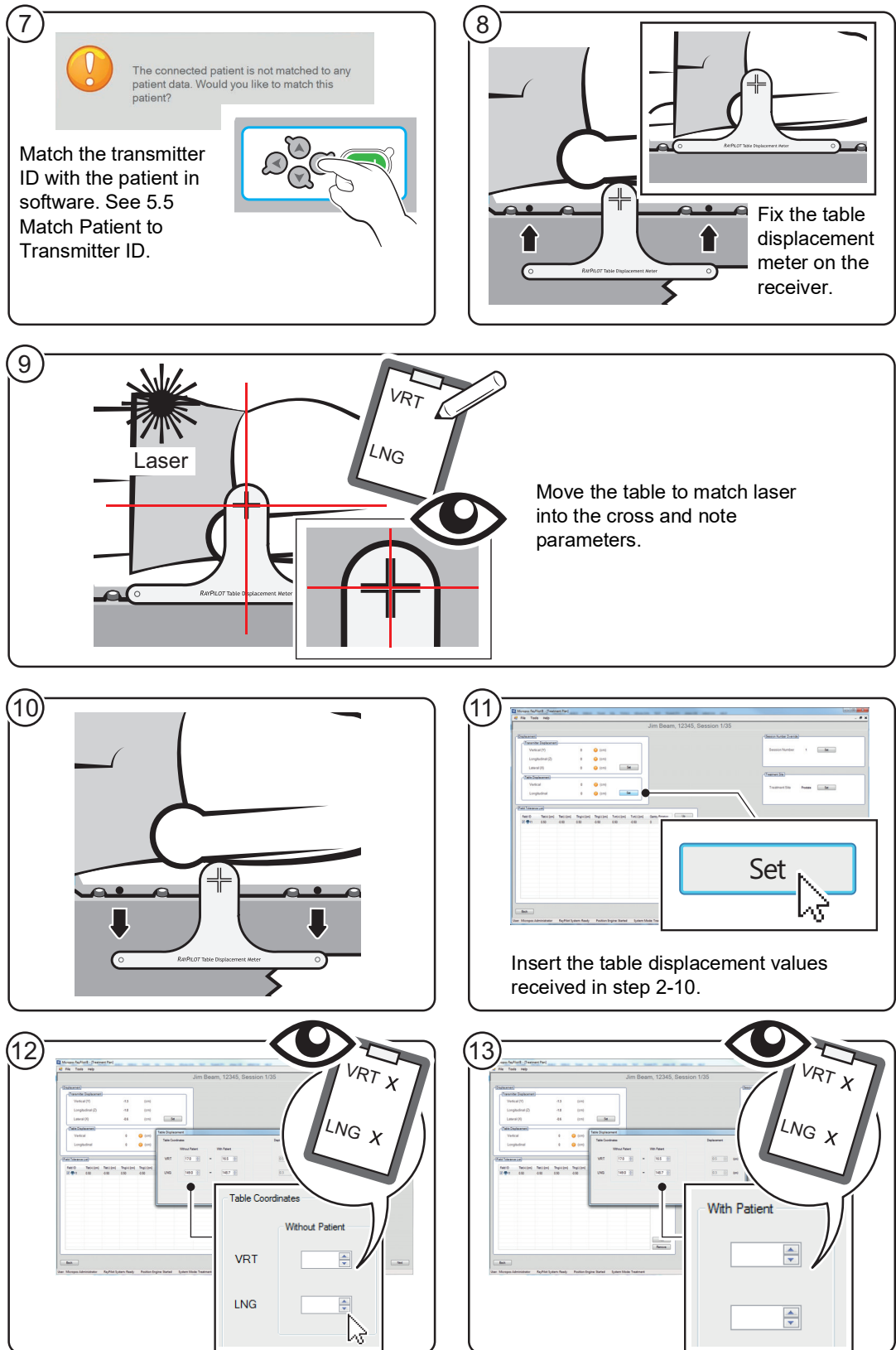

Figure 27 Instructions how to perform table displacement measurement (step 7-13)

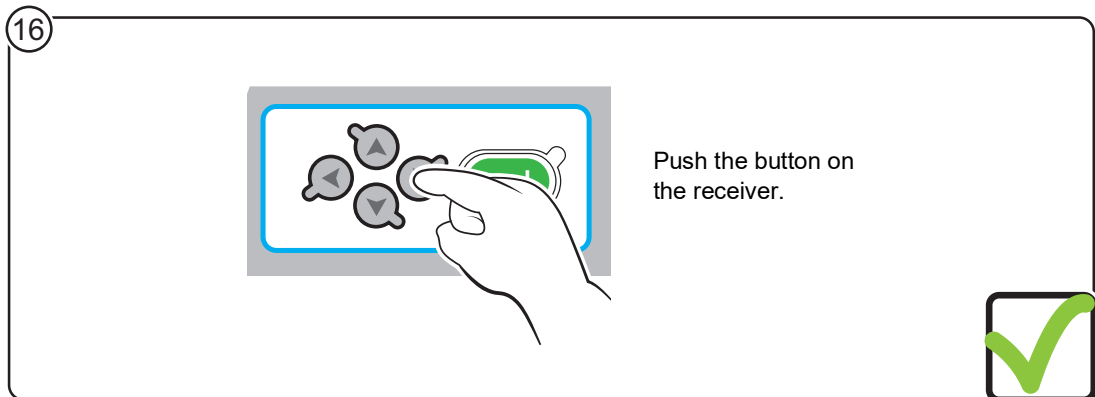
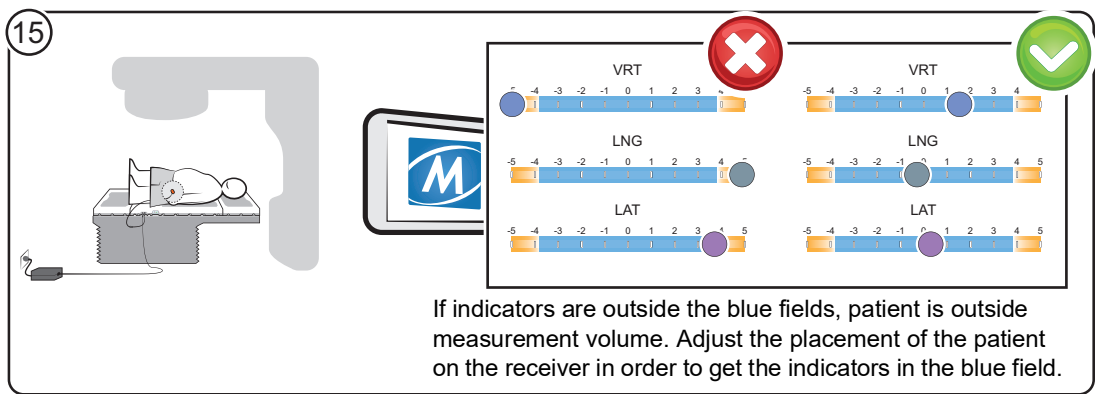
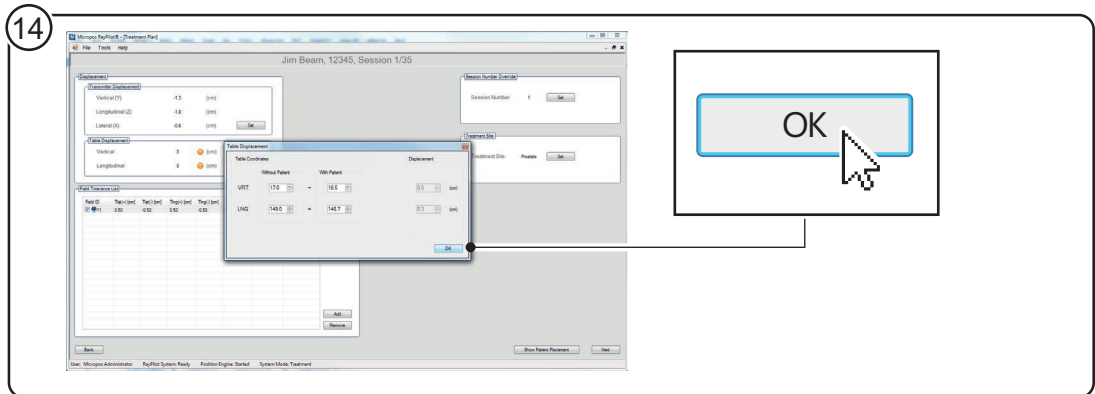
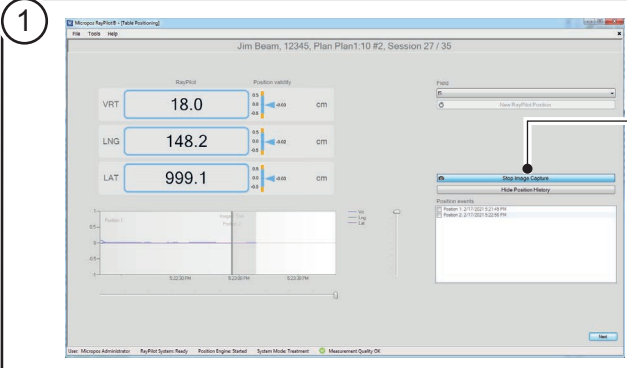

Figure 28 Instructions how to perform table displacement measurement (step 14-16)

### 5.6.3 Patient Set Up Guidance

1



**Start Image Capture**

Start Imaging in the external control system and Image Capture in Raypilot Software at the same time. If automatic beam detection is enabled image capture will automatically start when a CBCT is delivered.

2

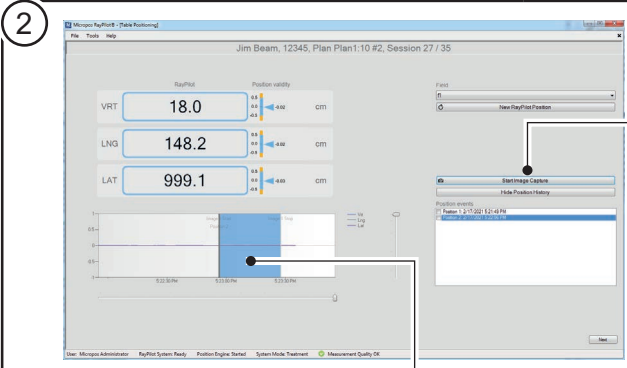

**Stop Image Capture**

When Imaging is completed in the external control system, click Stop Image Capture in Raypilot Software. If automatic beam detection is enabled image capture will automatically stop when a CBCT is completed.

**Note!**

If manually stopping image capture while a CBCT is being delivered, the user will be notified.

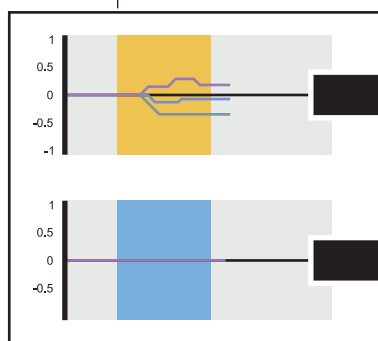

If Image Capture is outside tolerance, repeat step 1-2.

If Image Capture is inside tolerance, proceed to step 3.

Figure 29 Instructions for patient setup guidance (step 1-2)

3

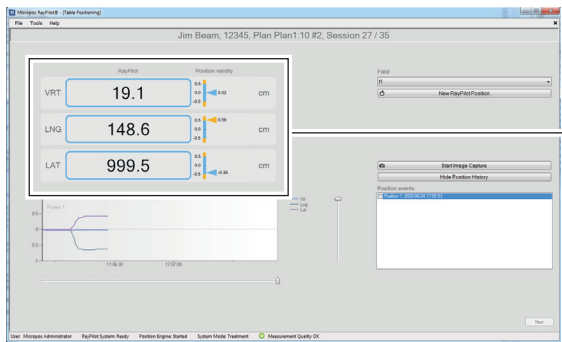

The Raypilot System indicates the couch coordinates for the patient set up. During the setup procedure, the target can move and thereby also the indicated coordinates for patient setup.

4

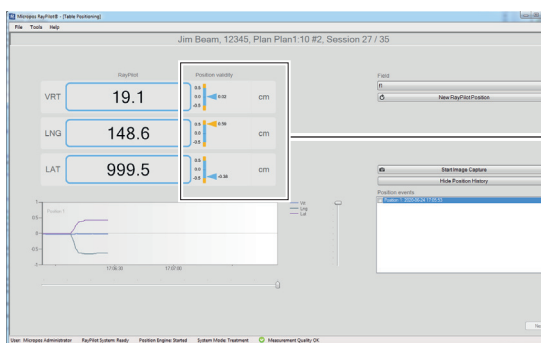

As long as the target is within tolerance during setup, it is indicated with a blue arrow on the side of coordinate.

If the target moves out of tolerance during setup, it is indicated with a yellow arrow on the side of the coordinate.



New Treatment Position

**Note!**  
If target moves out of position, click the "New Treatment Position"-button to get new coordinates.

5

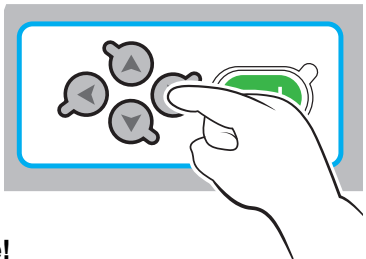

**Note!**  
Verify the treatment position provided by Raypilot System according to clinical routine.

6

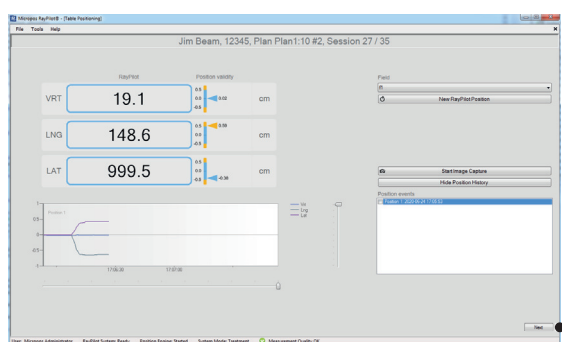

Next

When setup is verified, push the next button in the software interface to move to the real-time monitor.

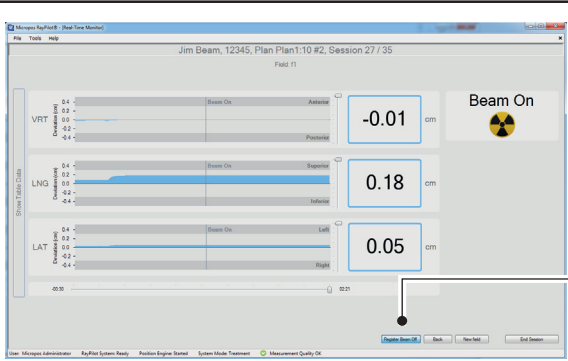

Figure 30 Instructions for patient setup guidance (step 3-6)

## 5.6.4 Real-time Monitor

**1**



Press Register beam on when treatment beam delivery starts. If automatic beam detection is enabled the start of the treatment beam will automatically be registered.

**Register Beam On**

**2**



Press Register beam off when treatment beam delivery ends. If automatic beam detection is enabled the end of the treatment beam will automatically be registered.

**Register Beam Off**

**3**

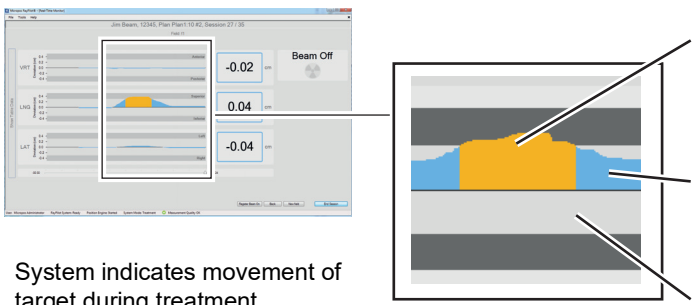

System indicates movement of target during treatment.

- Indicates that target has moved outside field tolerance parameter.
- Indicates that target is inside field tolerance parameters.
- Field tolerance parameters.

**Note!**  
If target moves out of field tolerance parameters, stop treatment. Wait until target moves back in place, or repeat 5.6.3 Patient Set Up Guidance.

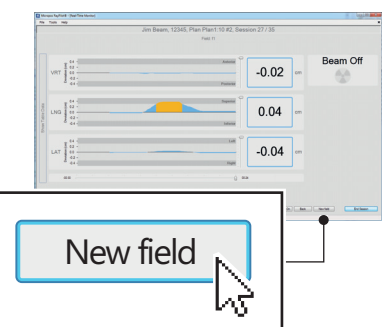

**Note!**  
When changing fields in the linear accelerator, change fields in the Raypilot System Software accordingly.

**New field**

Figure 31 Instructions for real-time monitor (step 1-3)

4

After completed treatment, press the "End Session"-button.

5

The window shows a summary of the target movement during treatment. Close the window when you are ready.

Field	LAT SDDev	LAT mean	LNG SDDev	LNG mean	VRT SDDev	VRT mean
#1	0.191	0.162	0.285	0.222	0.274	-0.081

Close

✔

Figure 32 Instructions for real-time monitor (step 4-5)

---

## 5.7 First Treatment with Table Positioning and Image Synchronization

### 5.7.1 Image Synchronization

With image capture in the Raypilot System, the user can get an indication of whether the target has moved more than the set tolerance during the setup with images.

### 5.7.2 Description

#### Note

In Step 5, make sure that the Raypilot Hypocath is connected all the way in.

In Step 5, make sure that the Raypilot Matching Network is not directly placed on the Receiver.

#### Task

The task is to perform patient treatment.

#### Task interval

During treatment.

#### Conditions

Equipment is set up, see 5.1 Set Up Equipment.

User is signed in to Raypilot Software, see 4.1 Sign In Raypilot Software.

Patient added to database, see 4.3.2 Add New Patient from DICOM-RT Database.

Daily control has been performed, see 5.2 Daily Quality Control.

Transmitter displacement information has been added, see 5.3 Add Patient Transmitter Displacement.

Field tolerance parameters has been added, see 5.4 Add Field Tolerance Parameters.

Transmitter ID and patient are matched, see 5.5 Match Patient to Transmitter ID.

### 5.7.3 Table Displacement and Patient Placement

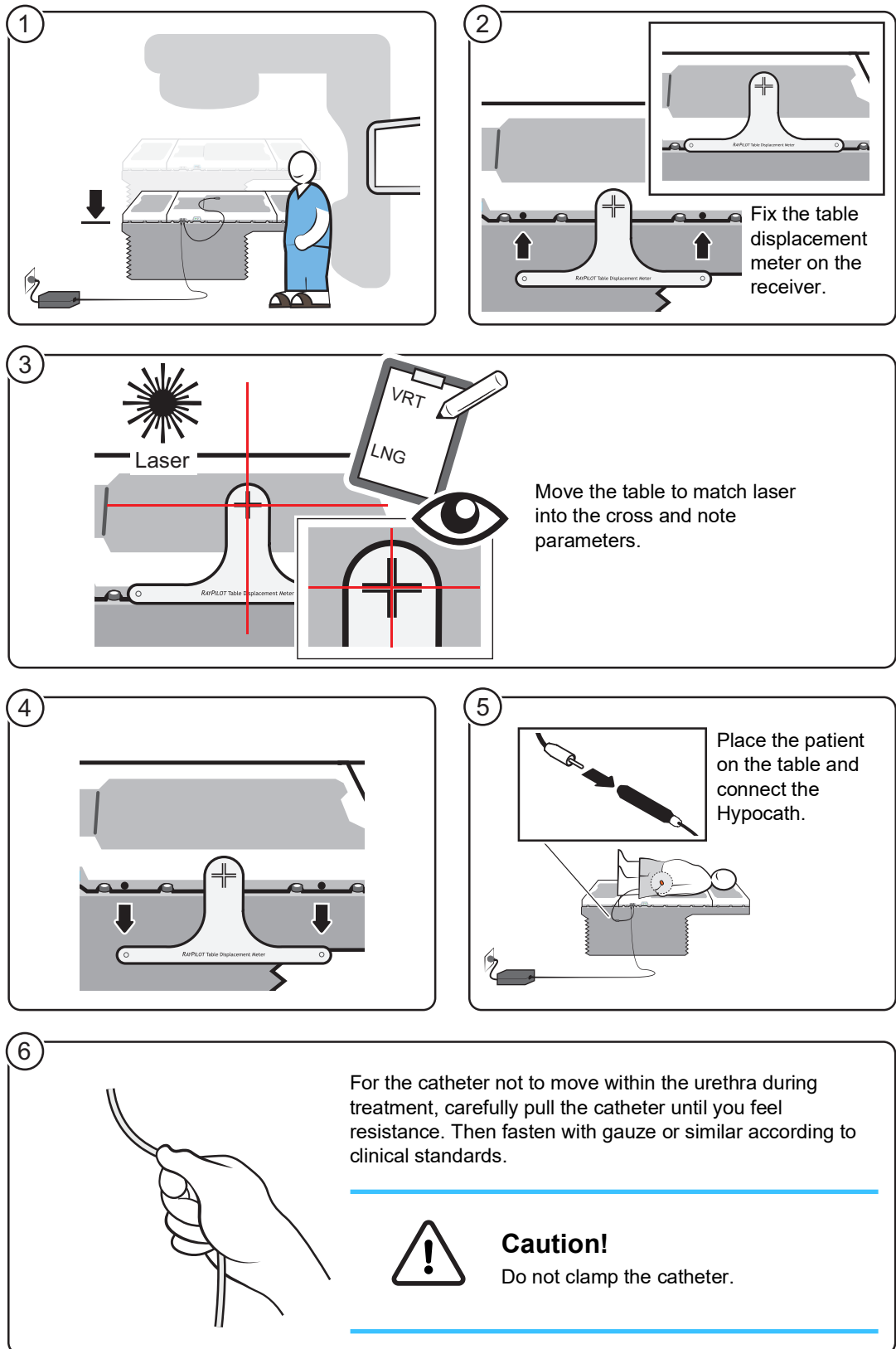

Figure 33 Instructions how to perform table displacement measurement (step 1-6)

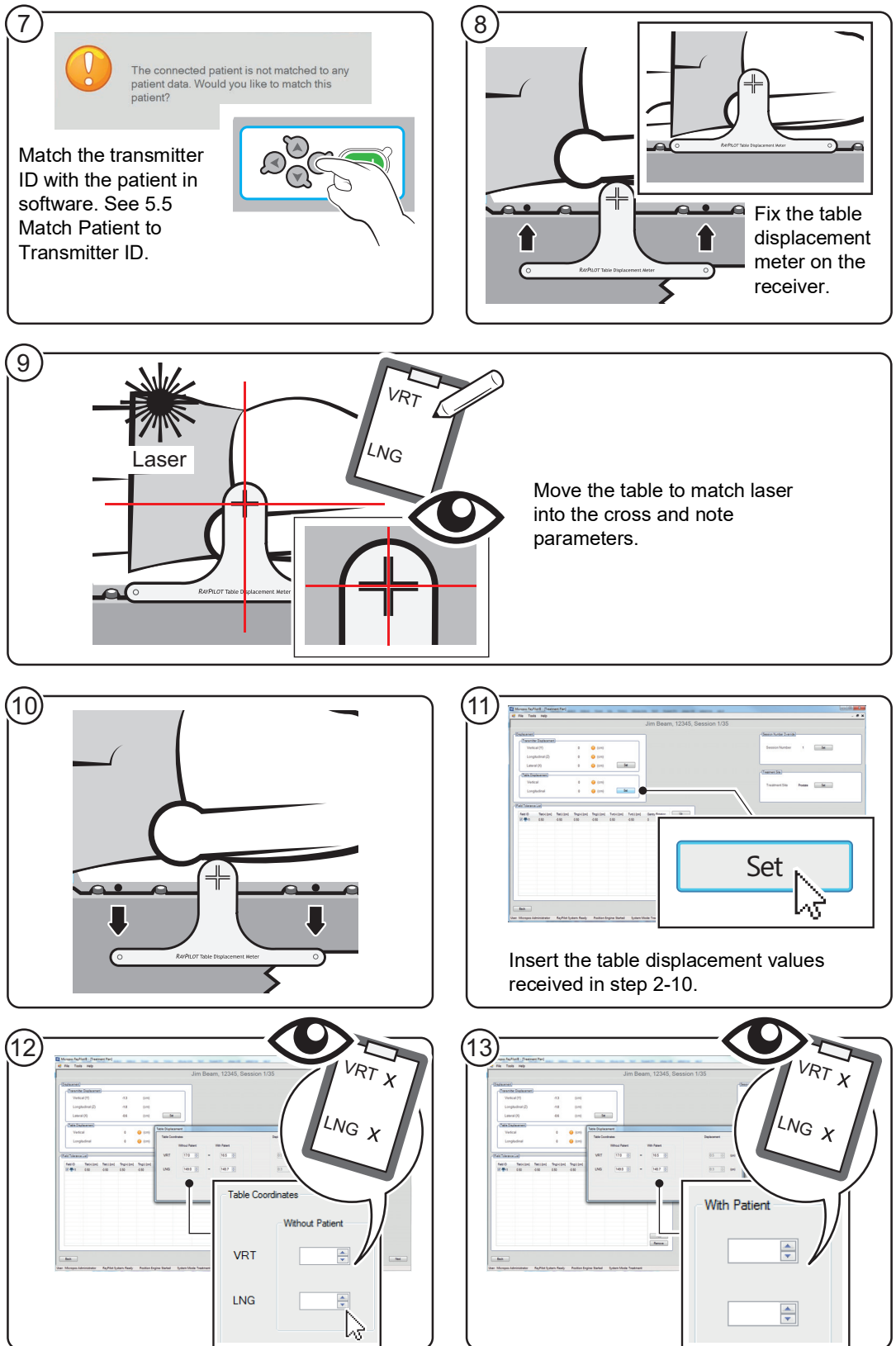

Figure 34 Instructions how to perform table displacement measurement (step 7-13)

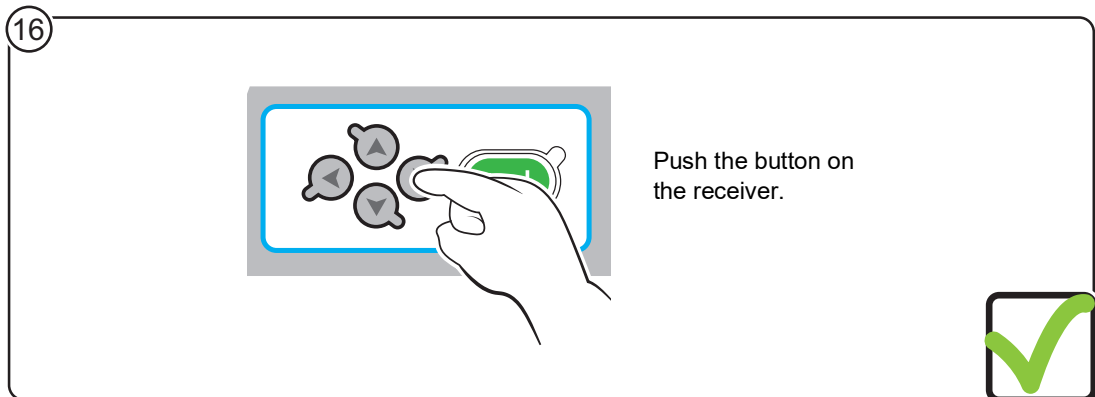
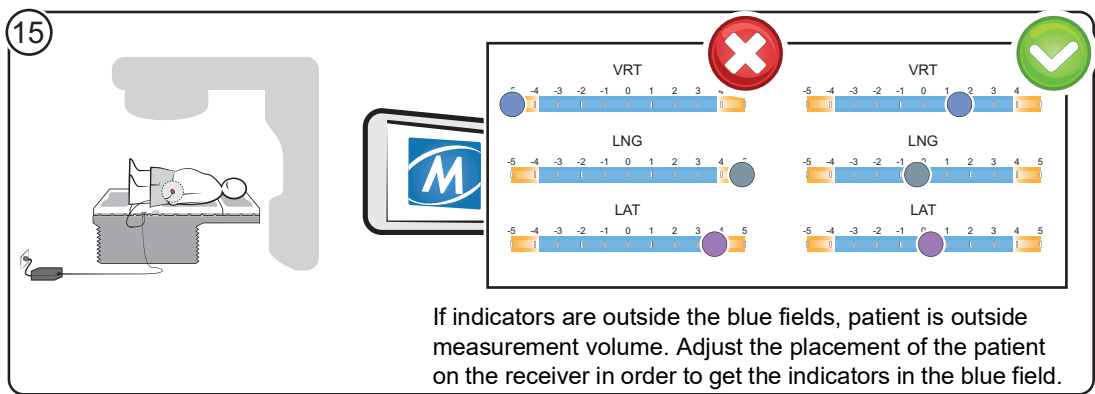
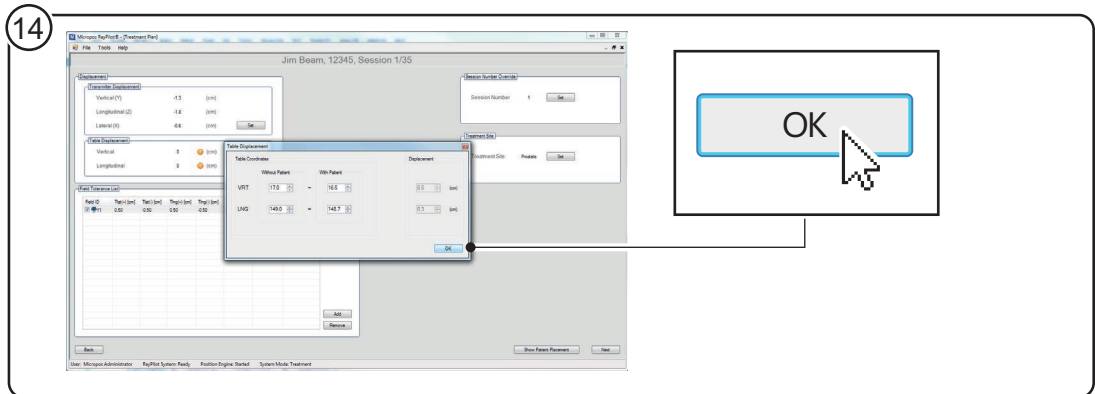
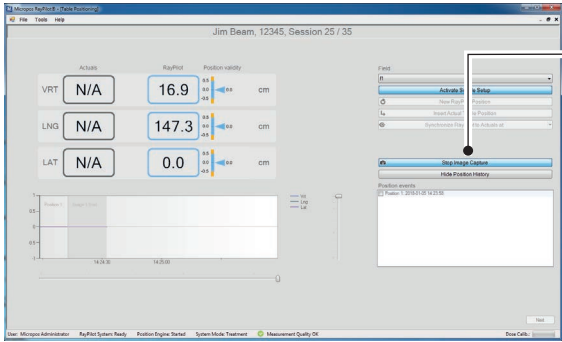

Figure 35 Instructions how to perform table displacement measurement (step 14-16)

## 5.7.4 Patient Set Up Guidance with Image Synchronization

**1**



**Start Image Capture**

Start Imaging in the external control system and Image Capture in Raypilot Software at the same time. If automatic beam detection is enabled image capture will automatically start when a CBCT is delivered.

**2**

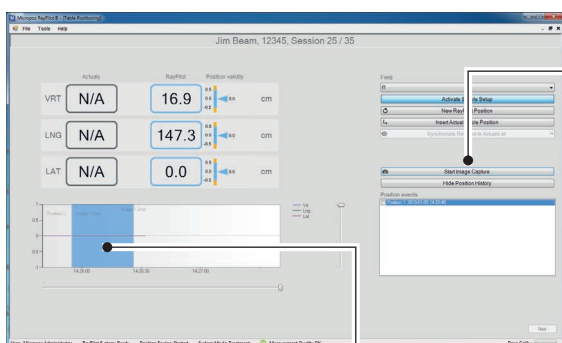

**Stop Image Capture**

When Imaging is completed in the external control system, click Stop Image Capture in Raypilot Software. If automatic beam detection is enabled image capture will automatically stop when a CBCT is completed.

**Note!**  
If manually stopping image capture while a CBCT is being delivered, the user will be notified.

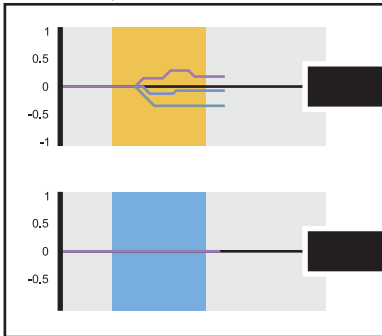

If Image Capture is outside tolerance, repeat step 1-2.

If Image Capture is inside tolerance, proceed to step 3.

**3**



Position the treatment table according to the coordinates given by the external control system.

Figure 36 Instructions for patient setup guidance with image synchronization (step 1-3)

4

Jim Beam, 12345, Session 25 / 35

	Actuals	Raypivot	Position validity
VRT	N/A	16.9	cm
LNG	N/A	147.3	cm
LAT	N/A	0.0	cm

Insert Actual Table Position

If the coordinates setup with external system deviates from the indicated coordinates in Raypivot System, insert the actual position of the treatment table into the Raypivot Software.

5

Jim Beam, 12345, Session 25 / 35

	Actuals	Raypivot	Position validity
VRT	16.9	16.9	cm
LNG	147.3	147.3	cm
LAT	0.0	0.0	cm

VRT 16.9

LNG 147.3

LAT 0.0

Use the arrows to adjust the inserted actual table position coordinates if necessary.

6

Jim Beam, 12345, Session 25 / 35

	Actuals	Raypivot	Position validity
VRT	16.9	16.9	cm
LNG	147.3	147.3	cm
LAT	0.0	0.0	cm

Apply Actual Table Position

The actual table position coordinates will be saved to the Raypivot Software.

7

Jim Beam, 12345, Session 25 / 35

	Actuals	Raypivot	Position validity
VRT	16.9	16.9	cm
LNG	147.0	147.3	cm
LAT	0.0	0.0	cm

Synchronize Raypivot to Actuals at:

Image 1 Start

Current Time

Synchronize the Raypivot Software to Actuals at a specific point in time. For example, when the Image used to position the table was taken.

Figure 37 Instructions for patient setup guidance with image synchronization (step 4-7)

8

The Raypilot System indicates the couch coordinates for the patient set up. During the setup procedure, the target can move and thereby also the indicated coordinates for patient setup.

9

As long as the target is within tolerance during setup, it is indicated with a blue arrow on the side of coordinate.

If the target moves out of tolerance during setup, it is indicated with a yellow arrow on the side of the coordinate.

New Treatment Position

**Note!**  
If target moves out of position, click the "New Treatment Position"-button to get new coordinates.

10

**Note!**  
Verify the treatment position provided by Raypilot System according to clinical routine.

11

Next

When setup is verified, push the next button in the software interface to move to the real-time monitor.

Figure 38 Instructions for patient setup guidance with image synchronization (step 8-11)

### 5.7.5 Real-time Monitor

**1**

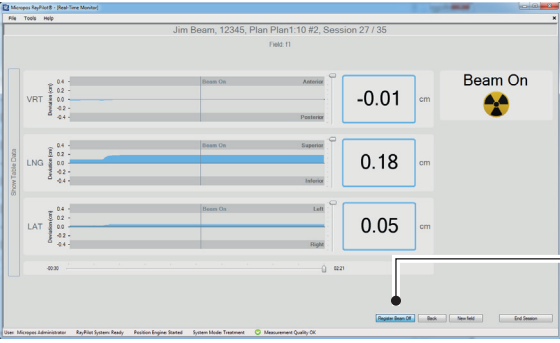

Press Register beam on when treatment beam delivery starts. If automatic beam detection is enabled the start of the treatment beam will automatically be registered.

**Register Beam On**

**2**

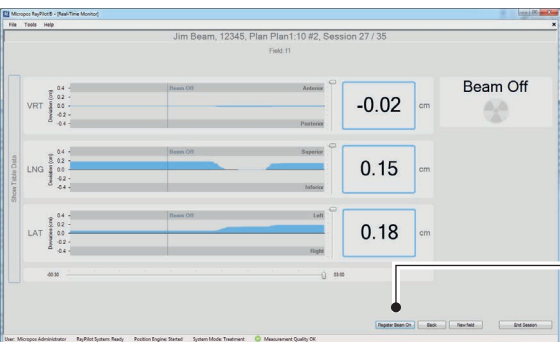

Press Register beam off when treatment beam delivery ends. If automatic beam detection is enabled the end of the treatment beam will automatically be registered.

**Register Beam Off**

**3**

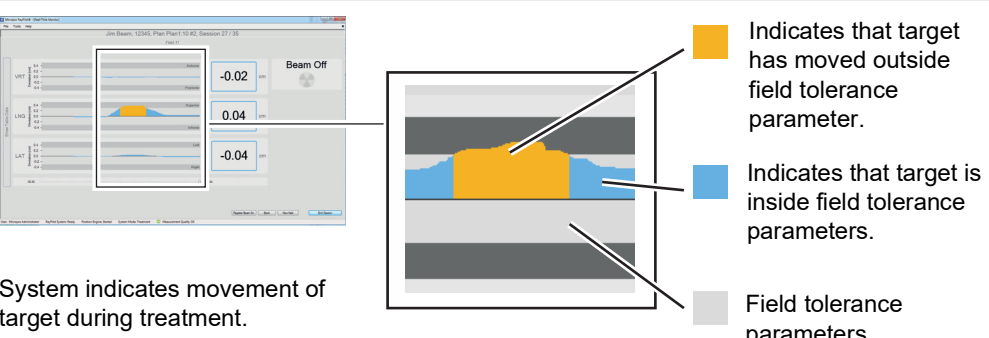

System indicates movement of target during treatment.

- Indicates that target has moved outside field tolerance parameter.
- Indicates that target is inside field tolerance parameters.
- Field tolerance parameters.

**Note!**

If target moves out of field tolerance parameters, stop treatment. Wait until target moves back in place, or repeat 5.6.3 Patient Set Up Guidance.

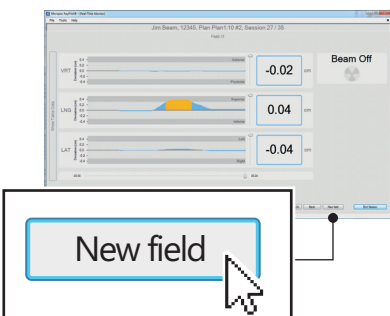

**Note!**

When changing fields in the linear accelerator, change fields in the Raypivot System Software accordingly.

**New field**

Figure 39 Instructions for real-time monitor (step 1-3)

4

After completed treatment, press the "End Session"-button.

5

The window shows a summary of the target movement during treatment. Close the window when you are ready.

Field	LAT 3DDev	LAT 3DDev	LAT 3DDev	LNG 3DDev	LNG 3DDev	LRT 3DDev	LRT 3DDev
RT	0.191	0.192	0.206	0.222	0.216	-0.091	

Close

Close

Figure 40 Instructions for real-time monitor (step 4-5)

---

## 5.8 Treatment with Standard Table Positioning

### 5.8.1 Description

#### Note

In Step 2, make sure that the Raypilot Hypocath is connected all the way in.

In Step 2, make sure that the Raypilot Matching Network is not directly placed on the Receiver.

#### Task

The task is to perform patient treatment.

#### Task interval

During treatment.

#### Conditions

Equipment is set up, see 5.1 Set Up Equipment.

User is signed in to Raypilot Software, see 4.1 Sign In Raypilot Software.

Patient added to database, see 4.3.2 Add New Patient from DICOM-RT Database.

Daily control has been performed, see 5.2 Daily Quality Control.

Transmitter displacement information has been added, see 5.3 Add Patient Transmitter Displacement.

Field tolerance parameters has been added, see 5.4 Add Field Tolerance Parameters.

Transmitter ID and patient are matched, see 5.5 Match Patient to Transmitter ID.

Table displacement has been added, see 5.6.2 Table Displacement and Patient Placement.

## 5.8.2 Patient Placement

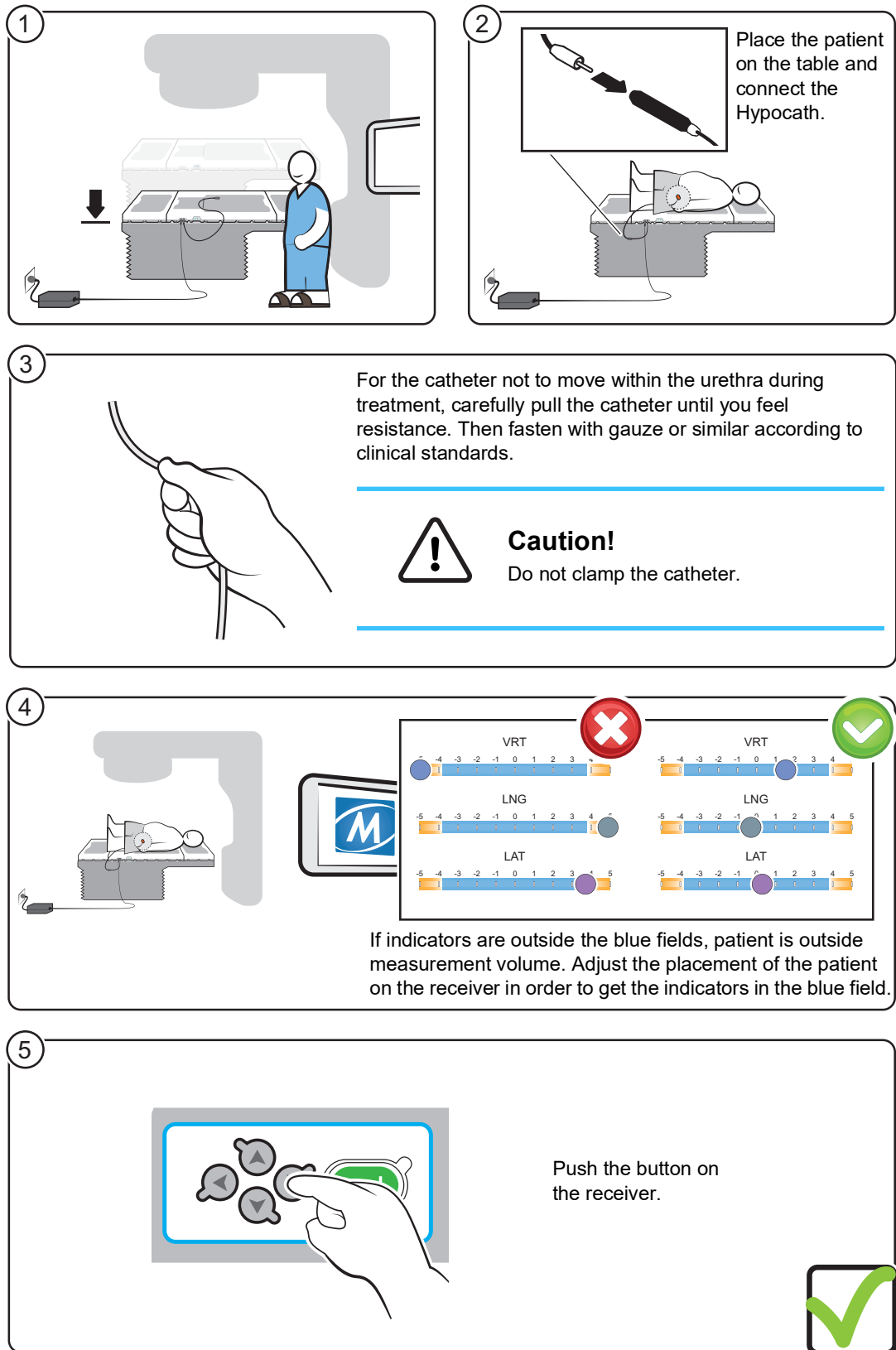
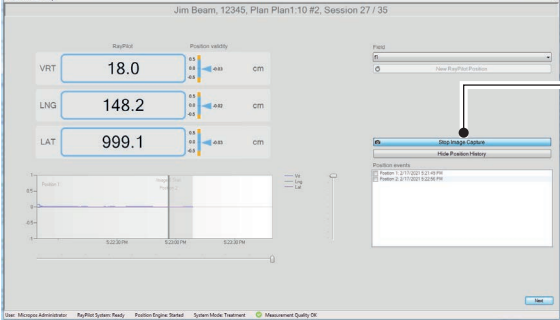

Figure 41 Instructions for patient placement

### 5.8.3 Patient Set Up Guidance

1



**Start Image Capture**

Start Imaging in the external control system and Image Capture in Raypilot Software at the same time. If automatic beam detection is enabled image capture will automatically start when a CBCT is delivered.

2

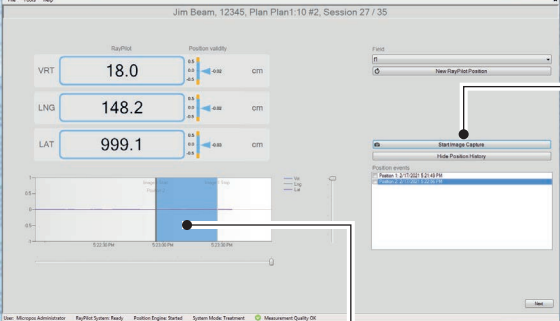

**Stop Image Capture**

When Imaging is completed in the external control system, click Stop Image Capture in Raypilot Software. If automatic beam detection is enabled image capture will automatically stop when a CBCT is completed.

**Note!**

If manually stopping image capture while a CBCT is being delivered, the user will be notified.

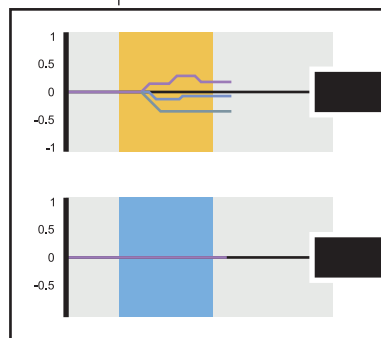

If Image Capture is outside tolerance, repeat step 1-2.

If Image Capture is inside tolerance, proceed to step 3.

Figure 42 Instructions for patient setup guidance (step 1-2)

3

The Raypilot System indicates the couch coordinates for the patient set up. During the setup procedure, the target can move and thereby also the indicated coordinates for patient setup.

4

As long as the target is within tolerance during setup, it is indicated with a blue arrow on the side of coordinate.

If the target moves out of tolerance during setup, it is indicated with a yellow arrow on the side of the coordinate.

New Treatment Position

**Note!**  
If target moves out of position, click the "New Treatment Position"-button to get new coordinates.

5

**Note!**  
Verify the treatment position provided by Raypilot System according to clinical routine.

6

Next

When setup is verified, push the next button in the software interface to move to the real-time monitor.

Figure 43 Instructions for patient setup guidance (step 3-6)

### 5.8.4 Real-time Monitor

1

Press Register beam on when treatment beam delivery starts. If automatic beam detection is enabled the start of the treatment beam will automatically be registered.

Register Beam On

2

Press Register beam off when treatment beam delivery end. If automatic beam detection is enabled the end of the treatment beam will automatically be registered.

Register Beam Off

3

System indicates movement of target during treatment.

- Indicates that target has moved outside field tolerance parameter.
- Indicates that target is inside field tolerance parameters.
- Field tolerance parameters.

**Note!**  
If target moves out of field tolerance parameters, stop treatment.  
Wait until target moves back in place, or repeat 5.6.3 Patient Set Up Guidance.

**Note!**  
When changing fields in the linear accelerator, change fields in the Raypilot System Software accordingly.

New field

Figure 44 Instructions for real-time monitor (step 1-3)

4

After completed treatment, press the "End Session"-button.

5

The window shows a summary of the target movement during treatment. Close the window when you are ready.

Figure 45 Instructions for real-time monitor (step 4-5)

---

## 5.9 Treatment with Table Positioning and Image Synchronization

### 5.9.1 Image Synchronization

With image capture in the Raypilot System, the user can get an indication of whether the target has moved more than the set tolerance during the setup with images.

### 5.9.2 Description

#### Note

In Step 2, make sure that the Raypilot Hypocath is connected all the way in.

In Step 2, make sure that the Raypilot Matching Network is not directly placed on the Receiver.

#### Task

The task is to perform patient treatment.

#### Task interval

During treatment.

#### Conditions

Equipment is set up, see 5.1 Set Up Equipment.

User is signed in to Raypilot Software, see 4.1 Sign In Raypilot Software.

Patient added to database, see 4.3.2 Add New Patient from DICOM-RT Database.

Daily control has been performed, see 5.2 Daily Quality Control.

Transmitter displacement information has been added, see 5.3 Add Patient Transmitter Displacement.

Field tolerance parameters has been added, see 5.4 Add Field Tolerance Parameters.

Transmitter ID and patient are matched, see 5.5 Match Patient to Transmitter ID.

Table displacement has been added, see 5.7.3 Table Displacement and Patient Placement.

### 5.9.3 Patient Placement

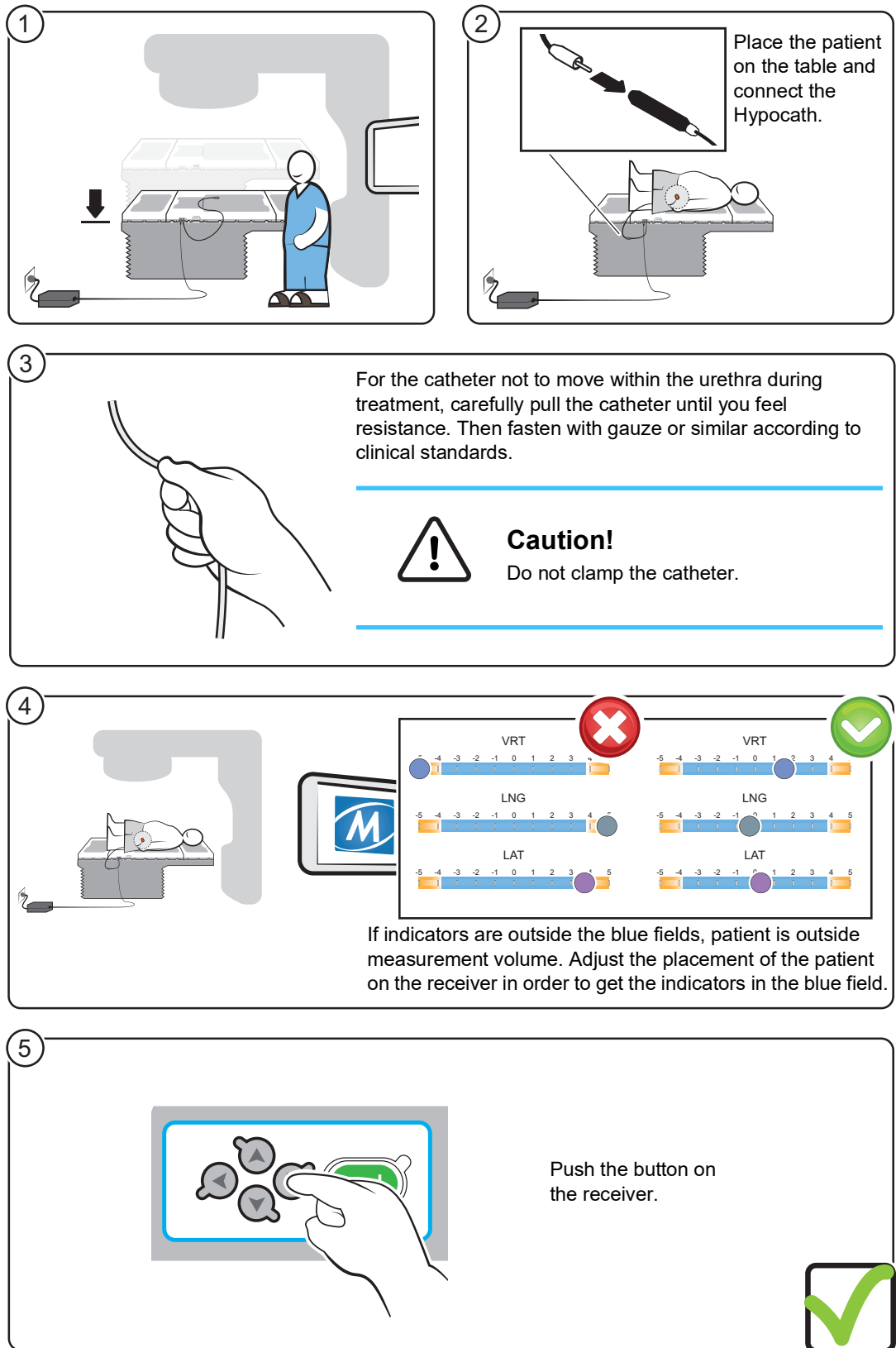
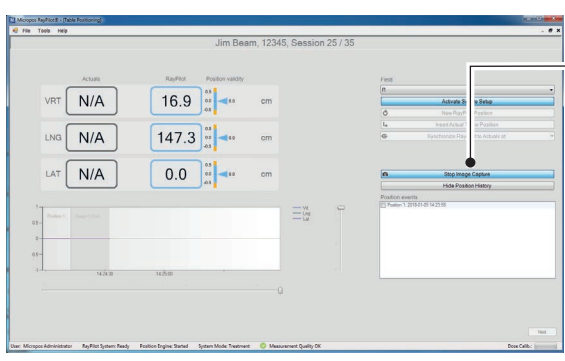



Figure 46 Instructions for patient placement

## 5.9.4 Patient Set Up Guidance with Image Synchronization

1







**Start Image Capture**

Start Imaging in the external control system and Image Capture in Raypilot Software at the same time. If automatic beam detection is enabled image capture will automatically start when a CBCT is delivered.

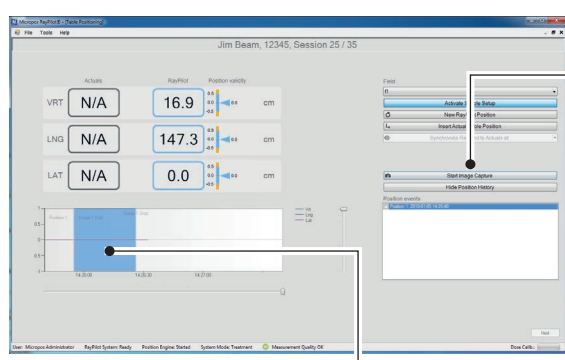
2





**Stop Image Capture**

When Imaging is completed in the external control system, click Stop Image Capture in Raypilot Software. If automatic beam detection is enabled image capture will automatically stop when a CBCT is completed.

**Note!**  
If manually stopping image capture while a CBCT is being delivered, the user will be notified.

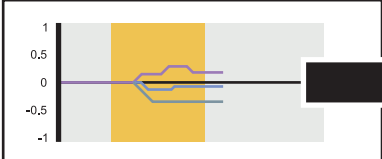

→ If Image Capture is outside tolerance, repeat step 1-2.

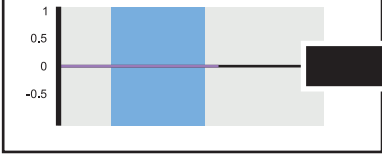

→ If Image Capture is inside tolerance, proceed to step 3.

3

Position the treatment table according to the coordinates given by the external control system.

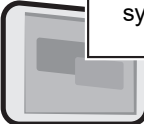

Figure 47 Instructions for patient setup guidance with image synchronization (step 1-3)

4

Jim Beam, 12345, Session 25 / 35

	Actuals	Raypilot	Position validity
VRT	N/A	16.9	cm
LNG	N/A	147.3	cm
LAT	N/A	0.0	cm

Insert Actual Table Position

If the coordinates setup with external system deviates from the indicated coordinates in Raypilot System, insert the actual position of the treatment table into the Raypilot Software.

5

Jim Beam, 12345, Session 25 / 35

	Actuals	Raypilot	Position validity
VRT	16.9	16.9	cm
LNG	147.3	147.3	cm
LAT	0.0	0.0	cm

VRT 16.9

LNG 147.3

LAT 0.0

Use the arrows to adjust the inserted actual table position coordinates if necessary.

6

Jim Beam, 12345, Session 25 / 35

	Actuals	Raypilot	Position validity
VRT	16.9	16.9	cm
LNG	147.3	147.3	cm
LAT	0.0	0.0	cm

Apply Actual Table Position

The actual table position coordinates will be saved to the Raypilot Software.

7

Jim Beam, 12345, Session 25 / 35

	Actuals	Raypilot	Position validity
VRT	16.9	16.9	cm
LNG	147.0	147.3	cm
LAT	0.0	0.0	cm

Synchronize Raypilot to Actuals at:

Image 1 Start

Current Time

Synchronize the Raypilot Software to Actuals at a specific point in time. For example, when the Image used to position the table was taken.

Figure 48 Instructions for patient setup guidance with image synchronization (step 4-7)

8

The Raypilot System indicates the couch coordinates for the patient set up. During the setup procedure, the target can move and thereby also the indicated coordinates for patient setup.

9

As long as the target is within tolerance during setup, it is indicated with a blue arrow on the side of coordinate.

If the target moves out of tolerance during setup, it is indicated with a yellow arrow on the side of the coordinate.

New Treatment Position

**Note!**  
If target moves out of position, click the "New Treatment Position"-button to get new coordinates.

10

**Note!**  
Verify the treatment position provided by Raypilot System according to clinical routine.

11

Next

When setup is verified, push the next button in the software interface to move to the real-time monitor.

Figure 49 Instructions for patient setup guidance with image synchronization (step 8-11)

### 5.9.5 Real-time Monitor

**1**

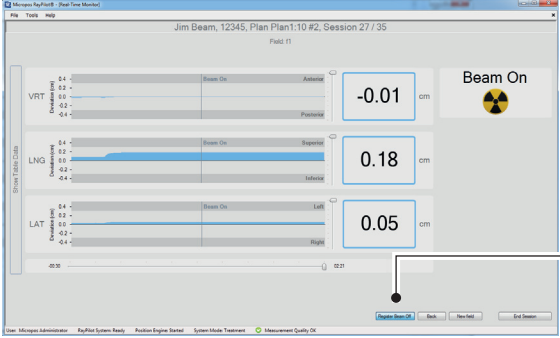

Press Register beam on when treatment beam delivery starts. If automatic beam detection is enabled the start of the treatment beam will automatically be registered.

**Register Beam On**

**2**

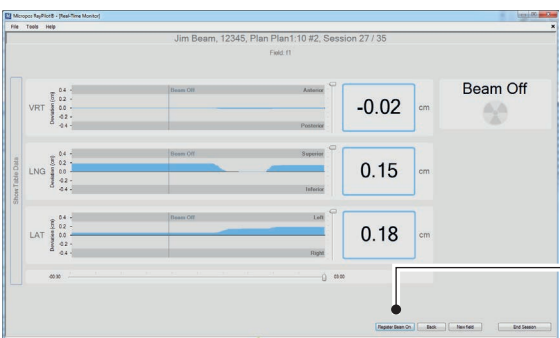

Press Register beam off when treatment beam delivery ends. If automatic beam detection is enabled the end of the treatment beam will automatically be registered.

**Register Beam Off**

**3**

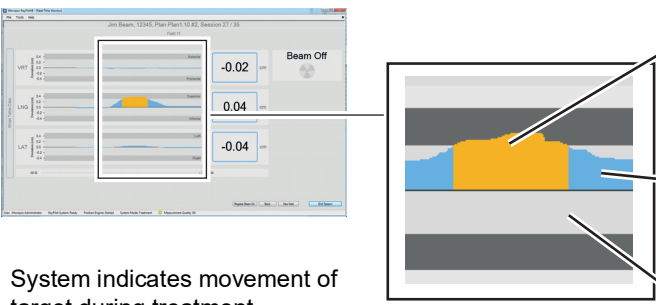

System indicates movement of target during treatment.

- Indicates that target has moved outside field tolerance parameter.
- Indicates that target is inside field tolerance parameters.
- Field tolerance parameters.

**Note!**

If target moves out of field tolerance parameters, stop treatment. Wait until target moves back in place, or repeat 5.6.3 Patient Set Up Guidance.

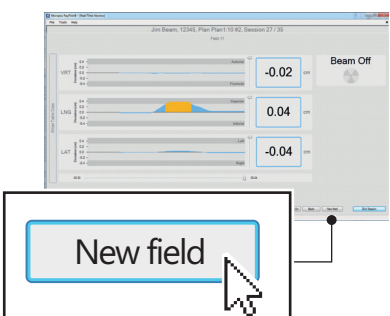

**Note!**

When changing fields in the linear accelerator, change fields in the Raypilot System Software accordingly.

**New field**

Figure 50 Instructions for real-time monitor (step 1-3)

4

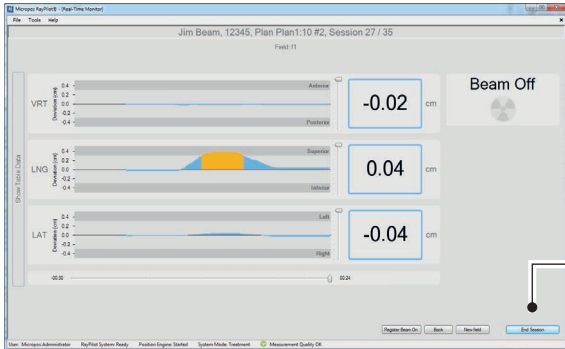

After completed treatment, press the "End Session"-button.

End Session

5



The window shows a summary of the target movement during treatment. Close the window when you are ready.

Close

✔

Figure 51 Instructions for real-time monitor (step 4-5)

---

## 5.10 Daily Shut Down Routine

### 5.10.1 Description

#### Task

The task is to remove Raypilot Receiver.

#### Task interval

Post-treatment.

#### Conditions

No specific condition for this task.

## 5.10.2 Instructions

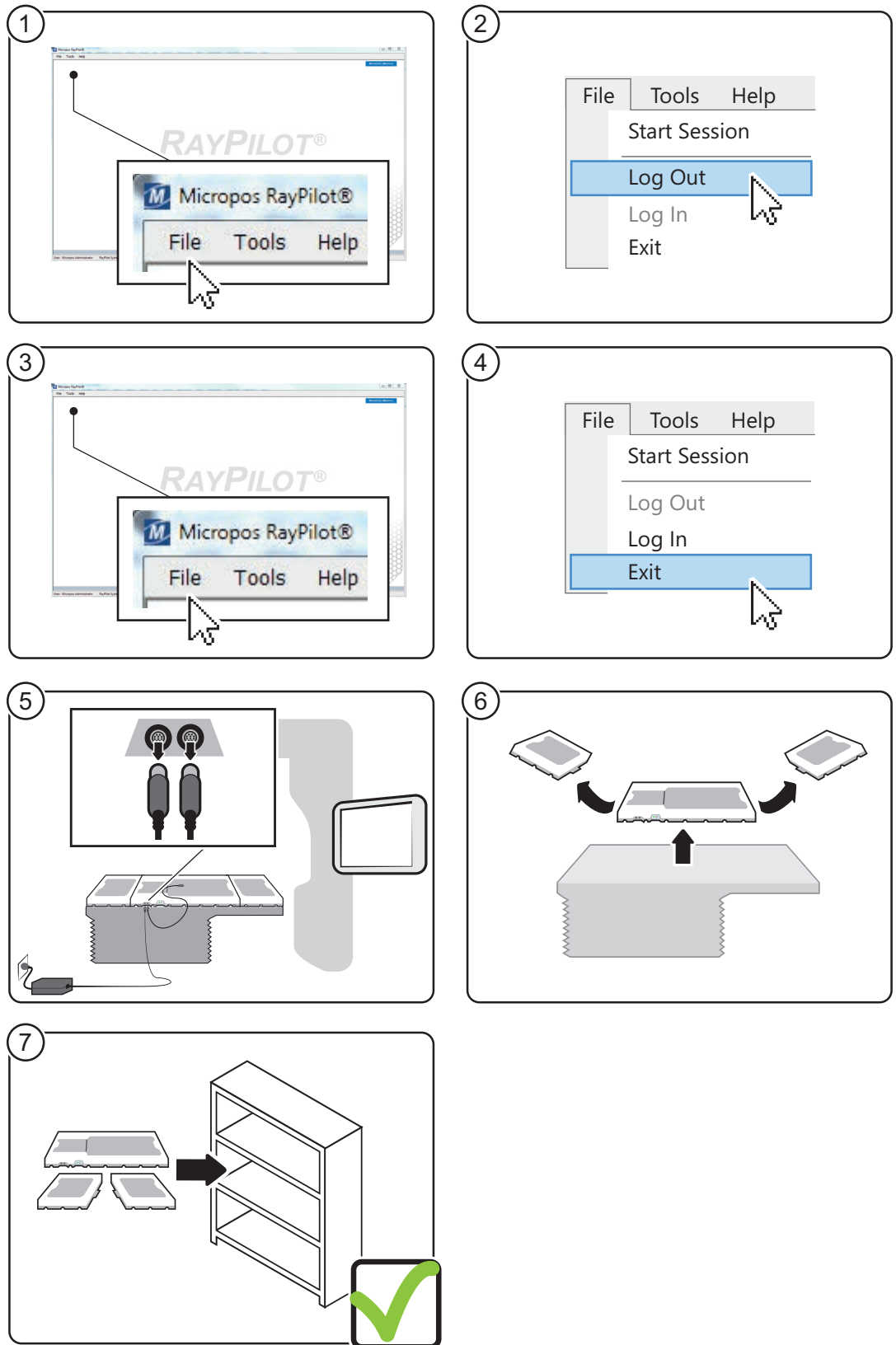

Figure 52 Instructions for daily shut down routine

---

## 5.11 Storage and Backup

To backup the Raypilot data, copy the folder C:\Backup.

The folder contains the following databases:

- **RaypilotPatientRecordsDB**  
Includes all the motion data and configurations used during all treatment sessions for each patient.
- **MicroposRaypilotDB**  
Includes all the installation data, patient-specific data for the moment of backup (ID data, field data, etc.).
- **RaypilotDicom**  
Includes all the Dicom-RT information sent to the Raypilot System (moved to Micropos Raypilot DB when imported).
- **RaypilotPatientDdepersonalizerDB**  
Includes the register mapping patient id to id used for anonymizing patient data.

The databases are stored in the .bak file format.

The data can be restored by following Microsoft procedures for restoring databases using Microsoft SQL server.

## 5.12 Multi Room Installation

### 5.12.1 Description

#### Task

The task is to gain knowledge about multiple room installation.

#### Task interval

Pre-treatment.

#### Conditions

Daily quality control is required for the specific system in the specific room before use, see 5.2 Daily Quality Control.

Transmitter displacement information has been added, see 5.3 Add Patient Transmitter Displacement.

### 5.12.2 Instructions

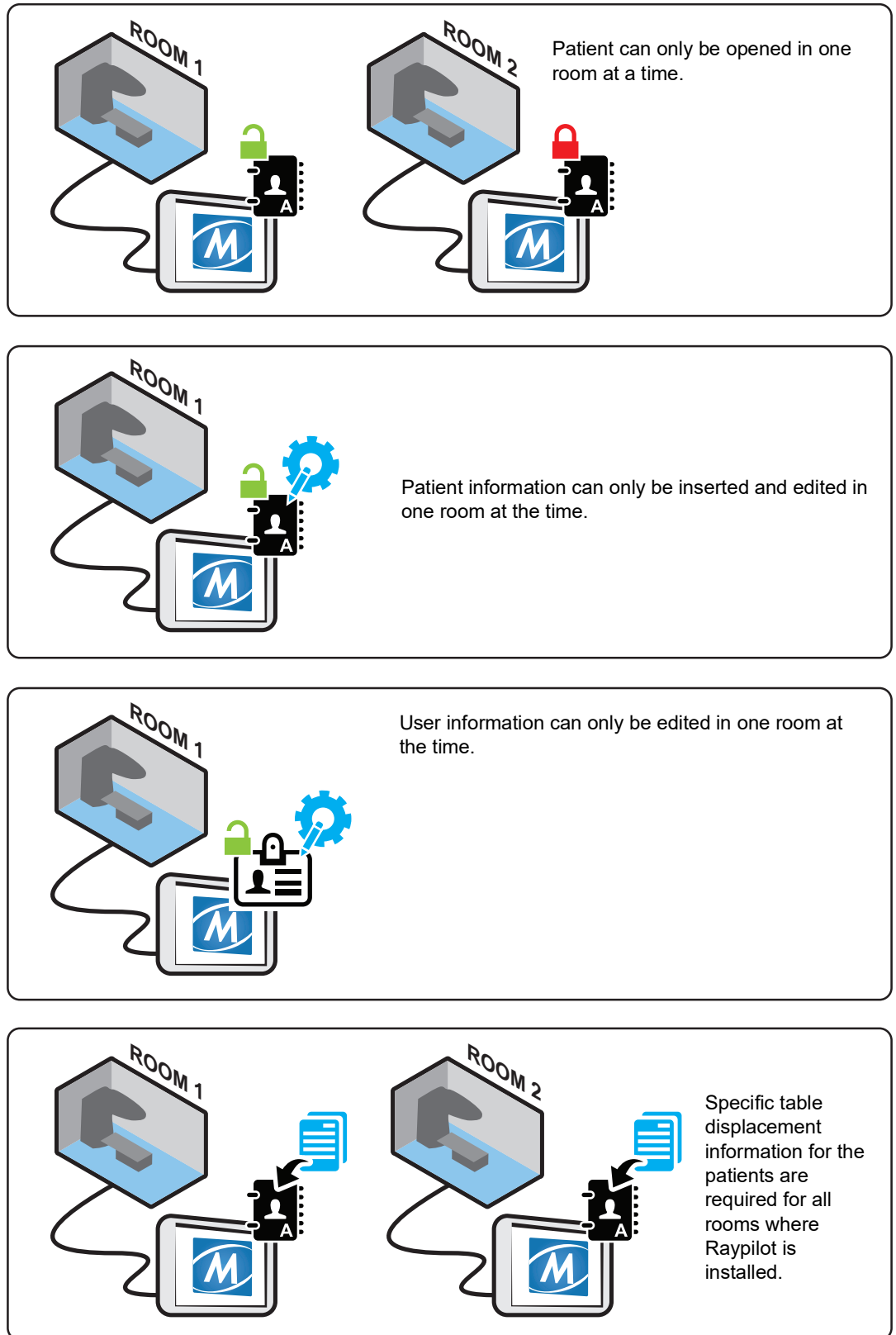

Figure 53 Instructions for multi room installation



---

# 6 Maintenance

All repairs are performed at Micropos Medical facilities.

## 6.1 Cleaning Equipment After Treatment

### 6.1.1 Description

#### Task

The task is to clean the equipment after treatment.

#### Task interval

Post-treatment.

#### Conditions

System is shut down, see 5.6 First Treatment with Standard Table Positioning.

Comply with local cleaning regulations.

Use a damp cloth (paper or cotton) soaked with water or alcohol (Ethanol 70-96%) to clean the system (see 6.1.2, Instructions on page 100).

## 6.1.2 Instructions

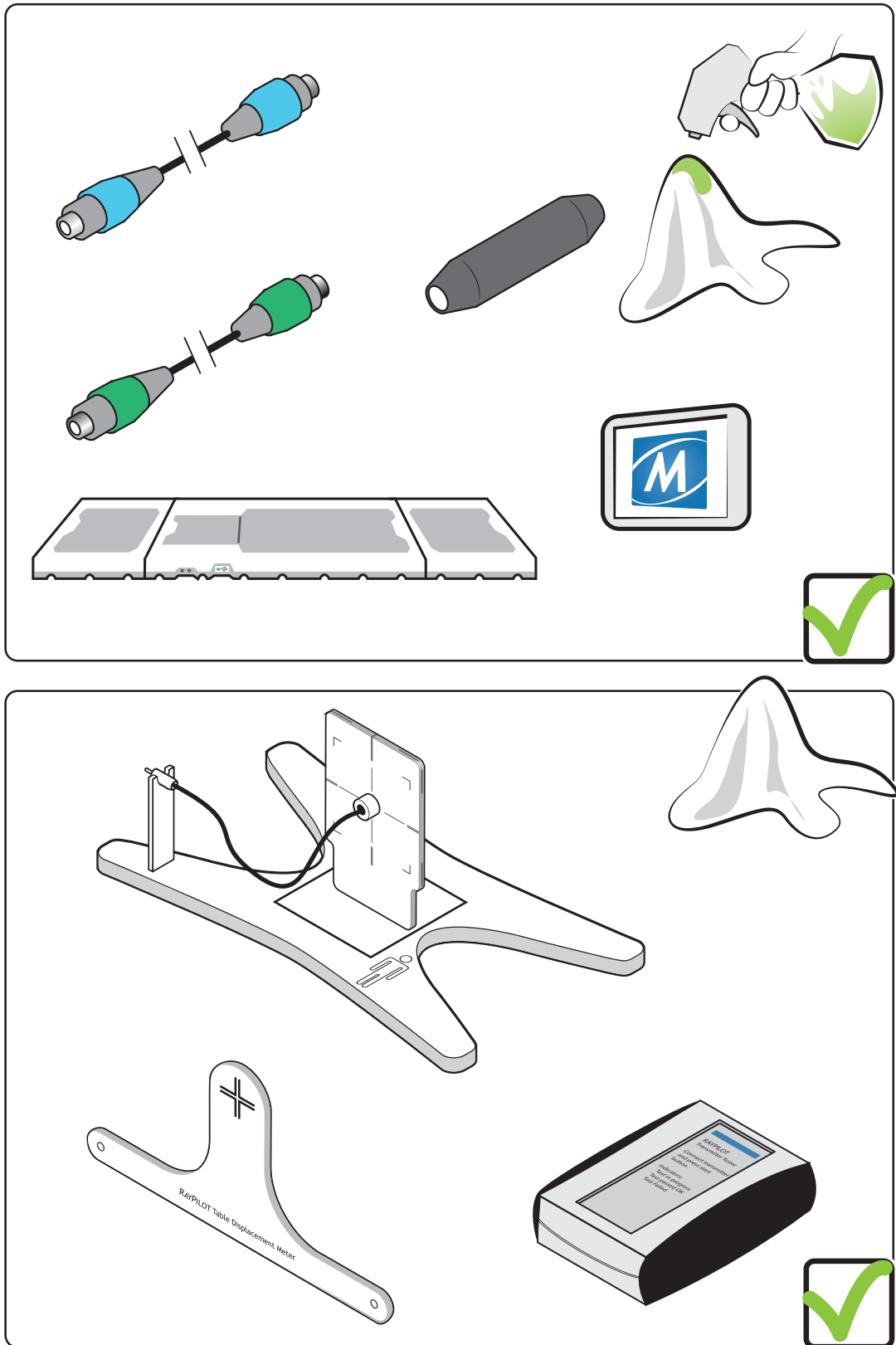

Figure 54 Instructions for cleaning of equipment

# 7 Troubleshooting

## 7.1 Equipment Problems

If you suspect problems with the functioning or operational safety of your Raypilot System, switch it off and contact Micropos Medical or a qualified technician immediately.

If the Raypilot System is not functioning, a plan without considering the treatment with the use of realtime monitoring of the target has to be created.

## 7.2 Error and Warning Messages

Error messages may be displayed during use of the system. A dialog box specifies the error.

If Measurement Quality indicators appears red during table positioning or real time monitor, it indicates an error. Double click the measurement quality indicator to open patient placement window for more error information.

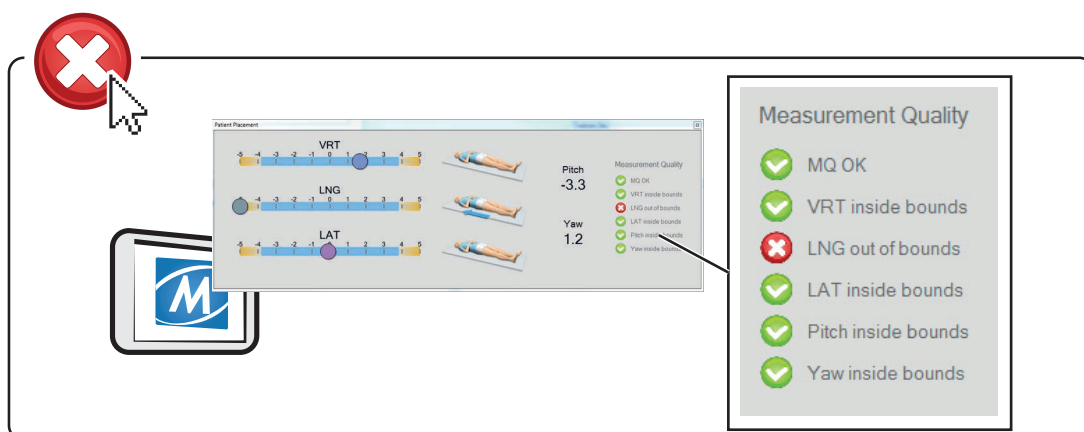

Figure 55 Example of error message when measurement quality indicator appears red

Measurement	Error message	Error description	Solution
MQ	out of bounds	Transmitter to far outside measurement volume.	Move patient closer to measurement volume.
VRT	out of bounds	Transmitter outside measurement volume.	Move patient along the VRT axis closer to measurement volume.
LNG	out of bounds	Transmitter outside measurement volume.	Move patient along the LNG axis closer to measurement volume.
LAT	out of bounds	Transmitter outside measurement volume.	Move patient along the LAT axis closer to measurement volume.

Measurement	Error message	Error description	Solution
Pitch	out of bounds	Transmitter outside measurement volume.	Reposition patient closer to measurement volume.
Yaw	out of bounds	Transmitter outside measurement volume.	Reposition patient closer to measurement volume.

Table 17 List of error descriptions

A 3D representation of the Measurement volume and where the transmitter is located can be found under Tools – Measurement volume 3D.

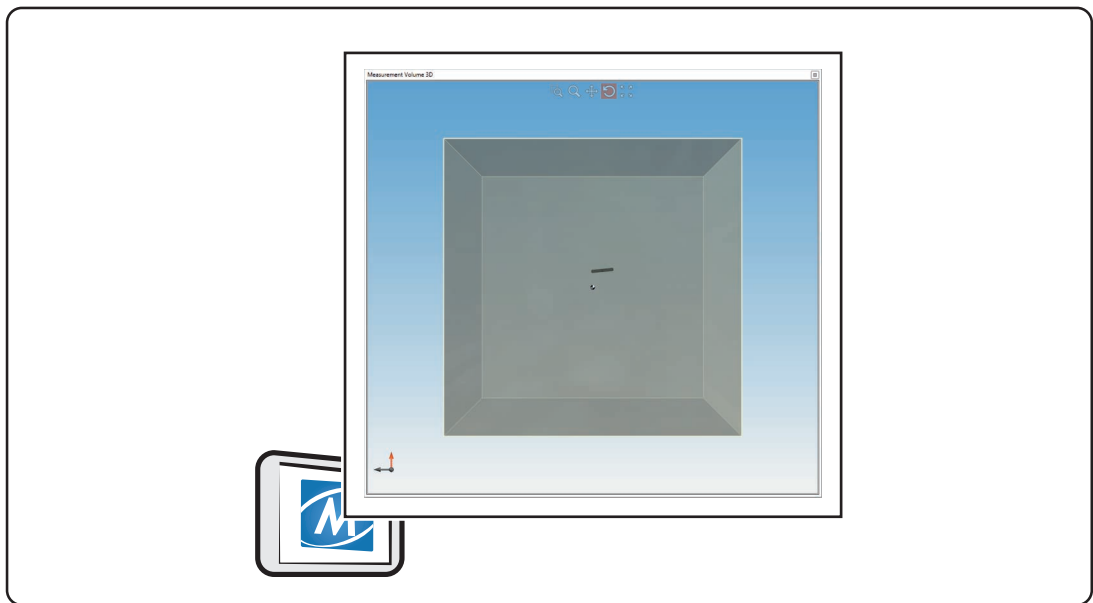

Figure 56 Measurement volume 3D

Apart from the transmitter being outside the measurement volume as in the example in figure 6-48, where the transmitter is out of bounds in the longitudinal direction, the measurement quality indicator warns for unreliable data if the system is not connected properly or if there is an external disturbance, such as metal objects like the Raypilot Matching Network or incompatible fixation equipment, in the vicinity of the system.

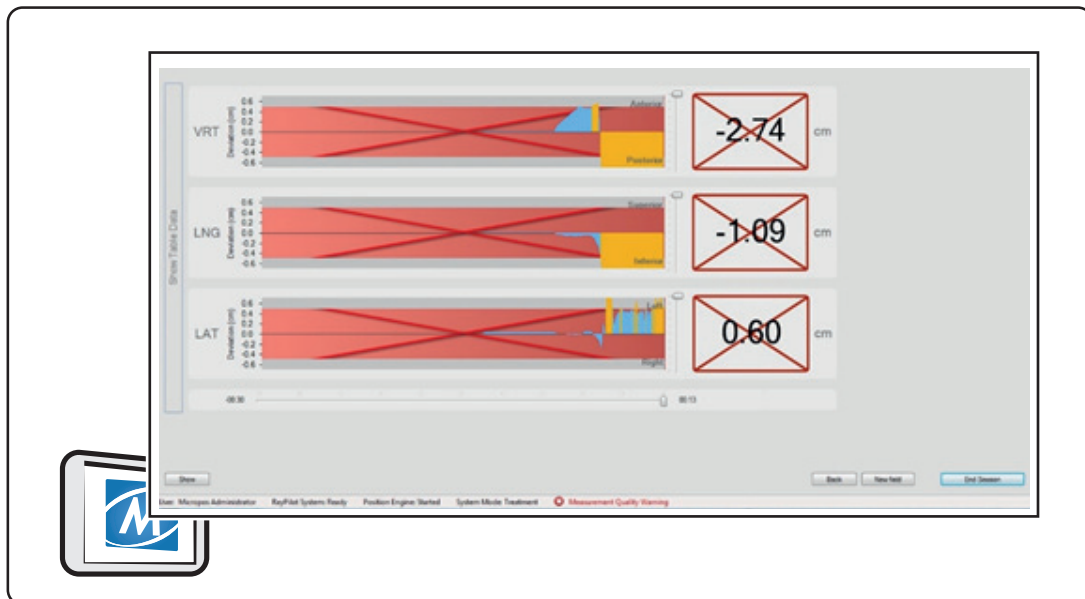

Figure 57 Example of how the error is displayed in the Raypilot Software user interface in real-time monitoring.

Further, the measurement quality indicator is also a warning if there is a mechanical failure or degradation in the system which influences the system performance.

### 7.2.1 Communication Problem with the Raypilot Receiver System

This error message occurs when there is a communication problem with the system.

Error message	Solution
Connection error with Raypilot Receiver. The system can not recover and needs to end the session	<ol style="list-style-type: none"> <li>1. Stop the treatment session (shut down the radiation from the radiotherapy device).</li> <li>2. Click on Close, and the session will close automatically.</li> <li>3. Disconnect the Raypilot System cable.</li> <li>4. Connect the Raypilot System cable again.</li> <li>5. Restart the treatment, see 5.7 First Treatment with Table Positioning and Image Synchronization.</li> </ol> <p>Note! The new session replaces the one that was closed.</p>

Table 18 Procedure when there is a problem with the Raypilot Receiver

Open system status window for service communication with Micropos Medical representative, if the error can not be resolved.

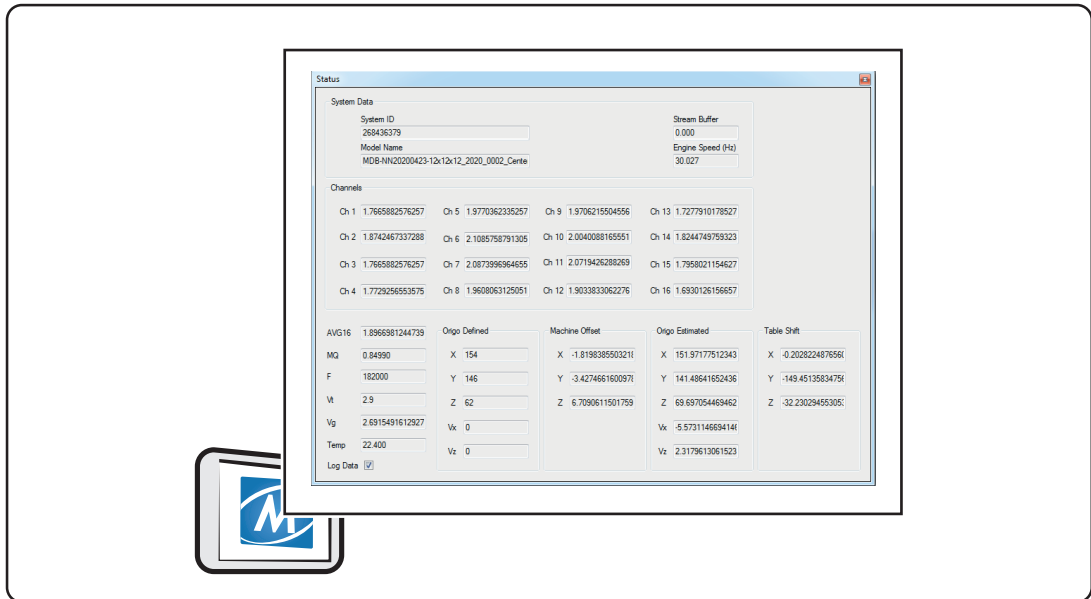
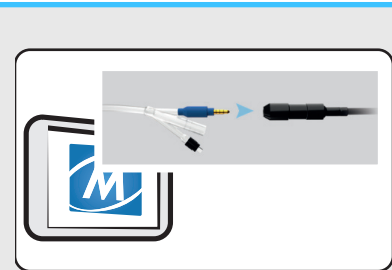

Figure 58 System status window

## 7.2.2 Communication Lost with the Transmitter

This error message occurs when the system has lost contact with the transmitter.

### Error message



The Hypocath is not properly connected.

### Solution

1. Place the patient in correct position. If the window closes, continue treatment.
2. Disconnect the transmitter cable from the Hypocath.
3. Connect the transmitter cable to the Hypocath again.
4. Check that the system is functioning correctly by performing a quality control test, see 5.2 Daily Quality Control.
5. Check the functioning of the Hypocath by using a transmitter tester, see 7.3 Raypilot Transmitter Errors.
6. Contact next level of maintenance support.

Table 19 Procedure when there is a problem with the transmitter

## 7.2.3 Communication Problem with Automatic Patient Identification

### Error message

Connected transmitter is already matched with other patient data.

The selected patient data is already matched with another transmitter.

### Solution

1. Switch the match to selected patient data.
1. Switch the match to the connected transmitter.

Error message	Solution
Broken ID chip.	<ol style="list-style-type: none"> <li>1. Double click on "Position Engine [status]".</li> <li>2. Use the drop down list and select the position engine that matches the transmitter and measurement volume that you intend to use in the treatment.</li> </ol>
Connected transmitter does not match any patient data.	<ol style="list-style-type: none"> <li>1. Match transmitter with patient data, see 5.5 Match Patient to Transmitter ID.</li> </ol>
Connected transmitter does not match the currently selected patient data.	<ol style="list-style-type: none"> <li>1. Select correct patient data.</li> <li>2. Create new patient data, see 4.3.2 Add New Patient from DICOM-RT Database.</li> </ol>

Table 20 Procedure when there is a problem with the automatic patient identification

### 7.3 Raypilot Transmitter Errors

If you suspect that the transmitter is damaged, use the transmitter tester to test its function.

1. Connect the transmitter to the transmitter tester and press the button.
2. The transmitter status is shown in the form of LEDs that light up (see the label on the transmitter tester for status descriptions)

If the transmitter status is not shown, verify that the transmitter tester is functioning correctly using the calibration transmitter, or use another transmitter tester. If an error is found with the transmitter, the transmitter must not be used for positioning.

If the transmitter function is lost, change the Raypilot Hypocath in the patient to be able to continue treatment with the Raypilot System. Match the new transmitter ID with the patient, see 5.5 Match Patient to Transmitter ID.

### 7.4 Measurement Noise

If any measurement noise or ripple is detected during the monitoring of the position, the disturbances does not affect the reliability of the measurements as long as the MQ value is within accepted bounds and the quality control is passed.



---

## 8 Appendix: Performance

### Raypilot Receiver:

Height:	30 mm
Width:	520 mm
Length:	1100 mm
Weight:	10 kg

### Raypilot Hypocath:

Length:	430 mm (including connector)
Width:	16 Fr
IP classification:	IP57

### Position update performance:

Update frequency:	30 times/s
-------------------	------------

### Measurement volume\*:

Measurement volume:	120 x 120 x 120 mm
Measurement height:	From 64 to 184 mm (from Raypilot Receiver surface)

\*Delivered calibrated according to this measurement volume. Other volumes upon request.

### Measurement precision:

Radial error:	P95 < 2 mm
Pitch:	+/- 40 degrees: +/- 5%
Yaw:	+/- 40 degrees: +/- 5%

### Operating frequency:

Transmitter:	123kHz; 13.62 dBµV/m (at 3m), no modulation
--------------	---



---

# 9 Appendix: Classification and Compliance

The following section contains information about the compliance of the Raypilot System with relevant standards. This section also contains information about the terms and conditions of installation and operation that have to do with electromagnetic immunity and electromagnetic radiation.

## 9.1 CE Marking



Compliance with the Medical Devices Directive 93/42/EEC.

## 9.2 Electric Shock Protection

Complies with IEC 60601-1:2005 + A1:2012 (SS-EN 60601-1:2006 + A1:2013), Class I, Type BF Applied Part. The parts connected to the patient are insulated against electric shock in accordance with EN 60601-1.

## 9.3 Requirements IEC 60601-1

The product does not have an essential performance as defined in the IEC 60601-1. Basic safety is fulfilled by incorporating 2xMOPP degree of isolation in the Power Supply unit.

Basic safety was monitored during each test by:

Visual observation of device and measurement accuracy observed via Raypilot Software.

## 9.4 Electromagnetic Compatibility and Leakage Current

The Raypilot System complies with the requirements in IEC 60601-1-2:2014 + A1:2020 (EN 60601-1-2:2015 + A1:2021).

The Raypilot System has been tested in accordance with IEC 60601-1-2:2014 + A1:2020 (EN 60601-1-2:2015 + A1:2021) with respect to electromagnetic compatibility. In addition, Raypilot has been tested in accordance with SS-EN 60601-1:2006 + A1: 2013 with respect to leakage current. The tables below show compliance with a range of test variables in the referenced IEC basic standards.

Raypilot System shall be used in Professional Healthcare Environment. Raypilot System is intended for use in an electromagnetic environment as specified in following subsections. The customer or the user of the Raypilot System must assure that it is used in such an environment.

### 9.4.1 Emission

Test	Limit	Electromagnetic environment - guidance
Conducted emission	CISPR 11, Group 1, Class A	Device uses RF energy only for its internal function. Therefore, its RF emissions are very low and are not likely to cause any interference in nearby electronic equipment.
Radiated emission	CISPR 11, Group 1, Class A	
Harmonic current emissions	IEC 61000-3-2, Class A	/
Voltage fluctuations and flicker	IEC 61000-3-3	

**Note!**

The EMISSIONS characteristics of this equipment make it suitable for use in industrial areas and hospitals (CISPR 11 class A). If it is used in a residential environment (for which CISPR 11 class B is normally required) this equipment might not offer adequate protection to radio-frequency communication services. The user might need to take mitigation measures, such as relocating or re-orienting the equipment.

**Note!**

Specification level, Radial error ≤2mm during testing. Measurement quality warning is acceptable.

**Note!**

Raypilot System shall be used in Professional Healthcare Environment.

### 9.4.2 Immunity Test Levels

Test	Compliance level	Electromagnetic environment - guidance
Electrostatic Discharge (IEC 61000-4-2)	Contact Discharge: ±8 kV Air Discharge: ±2 kV, ±4 kV, ±8 kV, ±15 kV	Floors should be wood, concrete or ceramic tile. If floors are covered with synthetic material, the relative humidity should be at least 30%.

Test	Compliance level	Electromagnetic environment - guidance
Radiated RF EM filed (IEC 61000-4-3)	80-2700 MHz; 1kHz AM 80%; 3 V/m	<p>Portable and mobile RF communications equipment should be used no closer to any part of the device, including cables, than the recommended separation distance calculated from the equation applicable to the frequency of the transmitter.</p> <p><b>Recommended separation distance</b></p> <p><math>d = 1.2\sqrt{P}</math> for 80 MHz to 800 MHz  <math>d = 2.3\sqrt{P}</math> for 800 MHz to 2.7 GHz</p> <p>where P is the maximum output power rating of the transmitter in watts (W) according to the transmitter manufacturer and d is the recommended separation distance in meters (m).</p>
Proximity fields form RF wireless communications equipment (IEC 61000-4-3)	385 MHz; Pulse Modulation: 18 Hz; 27 V/m 450 MHz, FM + 5 Hz deviation: 1 kHz sine; 28 V/m 710, 745, 780 MHz; Pulse Modulation: 217 Hz; 9 V/m 810, 870, 930 MHz; Pulse Modulation: 18 Hz; 28 V/m 1720, 1845, 1970 MHz; Pulse Modulation: 217 Hz; 28 V/m 2450 MHz; Pulse Modulation: 217 Hz; 28 V/m 5240, 5500, 5785 MHz; Pulse Modulation: 217 Hz; 9 V/m	Portable and mobile RF communications equipment should be used no closer to any part of the device, including cables, than the recommended separation distance 30 cm.
Electrical fast transients / bursts (IEC 61000-4-4)	Power lines: 2kV; 100 kHz repetition frequency Signal lines: 1kV; 100 kHz repetition frequency	Mains power quality should be that of a typical environment.
Surges (IEC 61000-4-5)	L-N: 1kV L-PE, N-PE: 2kV	Mains power quality should be that of a typical environment.

Test	Compliance level	Electromagnetic environment - guidance
Conducted disturbances induced by RF fields (IEC 61000-4-6)	0.15-80 MHz; 1kHz AM 80 %; 3 Vrms, 6 Vrms in ISM and amateur radio band	<p>Portable and mobile RF communications equipment should be used no closer to any part of the device, including cables, than the recommended separation distance calculated from the equation applicable to the frequency of the transmitter.</p> <p>Recommended separation distance</p> $d = 1.2\sqrt{P}$ <p>for 150 kHz to 80MHz</p> <p>where P is the maximum output power rating of the transmitter in watts (W) according to the transmitter manufacturer and d is the recommended separation distance in meters (m).</p>
Rated power frequency magnetic fields (IEC 61000-4-8)	30 A/m, 50 Hz	Power frequency magnetic fields should be at levels characteristic of a typical location in a typical commercial or hospital environment.
Voltage dips / Voltage interruptions (IEC 61000-4-11)	0% UT for 0.5 cycle at 0°, 45°, 90°, 135°, 180°, 225°, 270°, 315° 0% UT for 1 cycle at 0° 70% UT for 25/30 cycles at 0° 0% UT for 250/300 cycles 0°	Mains power quality should be that of a typical environment. If the user of the device requires continued operation during power mains interruptions, it is recommended that the device is powered from an uninterruptible power supply or battery.
Proximity magnetic fields IEC 61000-4-39	134.2kHz Pulse modulation 2.1kHz; 65A/m 13.56MHz Pulse modulation 50kHz; 7.5A/m	The recommended separation distance between the Raypilot System and RFID or similar devices is at least 15 cm.

---

# 10 Contact Information

## 10.1 Contact Details

Micropos Medical AB (publ)  
Adolf Edelsvärds gata 11  
SE-414 51 Gothenburg  
Sweden

[info@micropos.se](mailto:info@micropos.se)  
[www.micropos.se](http://www.micropos.se)

## 10.2 Technical Assistance

If you have any problems with the device, please contact Micropos Medical at:  
[support@micropos.se](mailto:support@micropos.se)

## 10.3 Authorized Representative

If empty not applicable





