

**MICROPOS MEDICAL**

**RAYPILOT®**  
SYSTEM

Instructions For Use

0700-5-EN

---

**Micropos Medical AB is not liable or bound by warranty if these instructions are not adhered to during installation, operation or maintenance, or if the equipment is modified without written consent from the manufacturer.**

© 2021 Copyright Micropos Medical AB

Micropos Medical AB can accept no responsibility for possible errors in catalogs, brochures and other printed material. Micropos Medical AB reserves the right to alter its products without notice. This also applies to products already on order provided that such alterations can be made without sub sequential changes being necessary in specifications already agreed.

All rights reserved.

RayPilot® and HypoCath® are registered trademarks of Micropos Medical AB.

The RayPilot system has been manufactured in compliance with IEC-60601-1 (Medical Electrical Equipment).

All other trademarks are the properties of their respective owners.

---

# Content

<b>1 Introduction</b>	<b>5</b>
1.1 Intended Use	5
1.2 Principle of Operation	5
1.3 Photos of RayPilot System Components	5
1.4 Illustrations of RayPilot System Components	7
1.5 Photos of RayPilot Accessories	8
1.6 Illustrations of RayPilot Accessories	9
1.7 System Overview	10
1.8 Multi Room Installation Overview	11
1.9 RayPilot Software User Interface	12
1.10 Definitions	15
<b>2 Safety</b>	<b>17</b>
2.1 Target Group	17
2.2 Installation and Service	17
2.3 Educational Requirements	17
2.4 Warnings	17
2.5 Cautions	18
2.6 Contraindication	19
2.7 Symbols on the Products	19
2.8 MR Unsafe	20
2.9 Treatment Duration	20
2.10 Security	20
<b>3 Settings</b>	<b>23</b>
3.1 Sign In RayPilot Software	23
3.2 Administrator's Function	24
3.3 Operator's Function	27
<b>4 Treatment</b>	<b>33</b>
4.1 Set Up Equipment	33
4.2 Daily Quality Control	35
4.3 Add Patient Transmitter Displacement	38
4.4 Add Field Tolerance Parameters	41

---

4.5 Match Patient to Transmitter ID . . . . .	43
4.6 First Treatment with Standard Table Positioning . . . . .	45
4.7 First Treatment with Table Positioning and Image Synchronization . . . . .	53
4.8 Treatment with Standard Table Positioning . . . . .	62
4.9 Treatment with Table Positioning and Image Synchronization . . . . .	67
4.10 Daily Shut Down Routine . . . . .	75
4.11 Storage and Backup . . . . .	77
4.12 Multi Room Installation . . . . .	77
<b>5 Maintenance . . . . .</b>	<b>79</b>
5.1 Cleaning Equipment After Treatment . . . . .	79
<b>6 Troubleshooting . . . . .</b>	<b>81</b>
6.1 Equipment Problems. . . . .	81
6.2 Error and Warning Messages . . . . .	81
6.3 RayPilot Transmitter Errors. . . . .	85
<b>7 Appendix: Technical Specifications . . . . .</b>	<b>87</b>
<b>8 Appendix: Classification and Compliance . . . . .</b>	<b>89</b>
8.1 CE Marking . . . . .	89
8.2 Electric Shock Protection . . . . .	89
8.3 Requirements IEC 60601-1. . . . .	89
8.4 Electromagnetic Compatibility and Leakage Current . . . . .	89

---

# 1 Introduction

## 1.1 Intended Use

The RayPilot® system is intended for use as an adjunct in treatment planning and radiation therapy, to align and monitor the patient's position relative to the isocentre of a linear accelerator. The RayPilot® system provides accurate, precise, and continuous localization of a treatment isocentre by using RayPilot® HypoCath®, a transmitter located within one lumen of a urinary catheter, for prostate localization and tracking, and automatic patient identification.

## 1.2 Principle of Operation

The RayPilot system is an electromagnetic tracking system that measures the transmitter's position in three axes: X, Y, and Z, and in the angles pitch and yaw.

The RayPilot system can be used for initial setup guidance of the target, before verifying the position according to clinical routines for patient setup. After setup, the system is used for continuous monitoring of the target to verify that it remains in the accepted setup position during radiation delivery. If the target moves out of defined position tolerances, the user can take necessary actions, such as stopping the radiation and repositioning the patient.

With the Patient ID, you can ensure that the right patient is connected at all treatment fractions, once the transmitter ID is matched to a specific patient.

The user has the option of adding the functionality to automatically detect and visualize CBCT and beam on/off events in the RayPilot system.

This manual covers instructions for using the RayPilot system. For information covering the RayPilot HypoCath and the RayPilot ViewCath, see the separate manual *Instructions for use RayPilot HypoCath* and *Instructions for use RayPilot ViewCath*.

## 1.3 Photos of RayPilot System Components

Component	Description	Part no
	RayPilot receiver (BF applied part)	2020

Component	Description	Part no
	RayPilot extension plate	2021
	RayPilot software*	3004
	RayPilot HypoCath (sterile) (CF applied part)	1004
	RayPilot ViewCath (sterile)	1005
	RayPilot transmitter cable (blue)	6001
	RayPilot system cable (green)	6002



Component	Description	Part no
	RayPilot matching network	6004
	RayPilot power box	6003

Table 1 Photos of RayPilot Components

## 1.4 Illustrations of RayPilot System Components

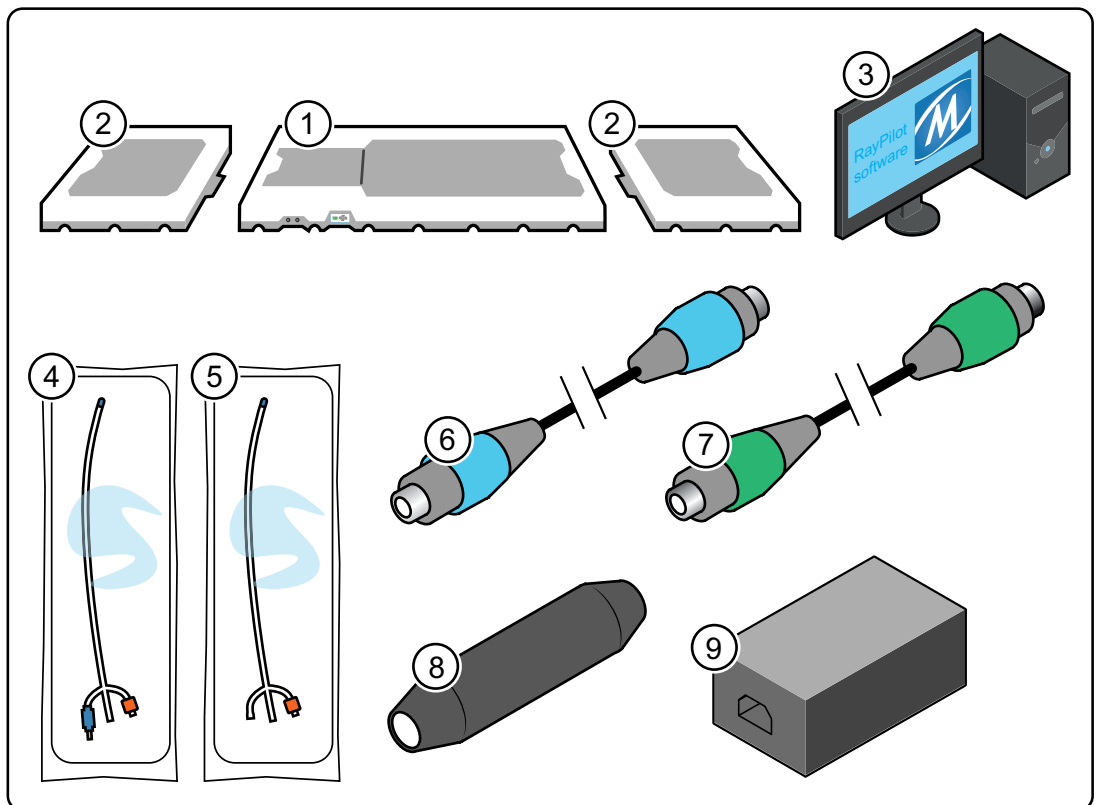

Figure 1 RayPilot system components

No	Description	Part no
1	RayPilot receiver (BF applied part)	2020
2	RayPilot extension plate	2021
3	RayPilot software*	3004
4	RayPilot HypoCath (sterile) (CF applied part)	1004
5	RayPilot ViewCath (sterile)	1005
6	RayPilot transmitter cable	6001
7	RayPilot system cable	6002
8	RayPilot matching network	6004
9	RayPilot power box	6003

\*RayPilot software is installed on a computer and visualized on a display in the control and treatment room

Table 2 List of RayPilot system components in figure 1

## 1.5 Photos of RayPilot Accessories



Component	Description	Part no
	RayPilot quality control kit: <ul style="list-style-type: none"> <li>• QA tower</li> <li>• QA base plate</li> <li>• QC transmitter</li> </ul>	4005
	RayPilot table displacement meter	4007
	RayPilot transmitter tester	4006

Table 3 Photos of RayPilot Accessories

## 1.6 Illustrations of RayPilot Accessories

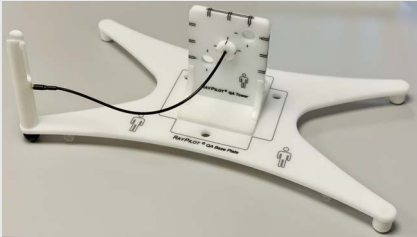
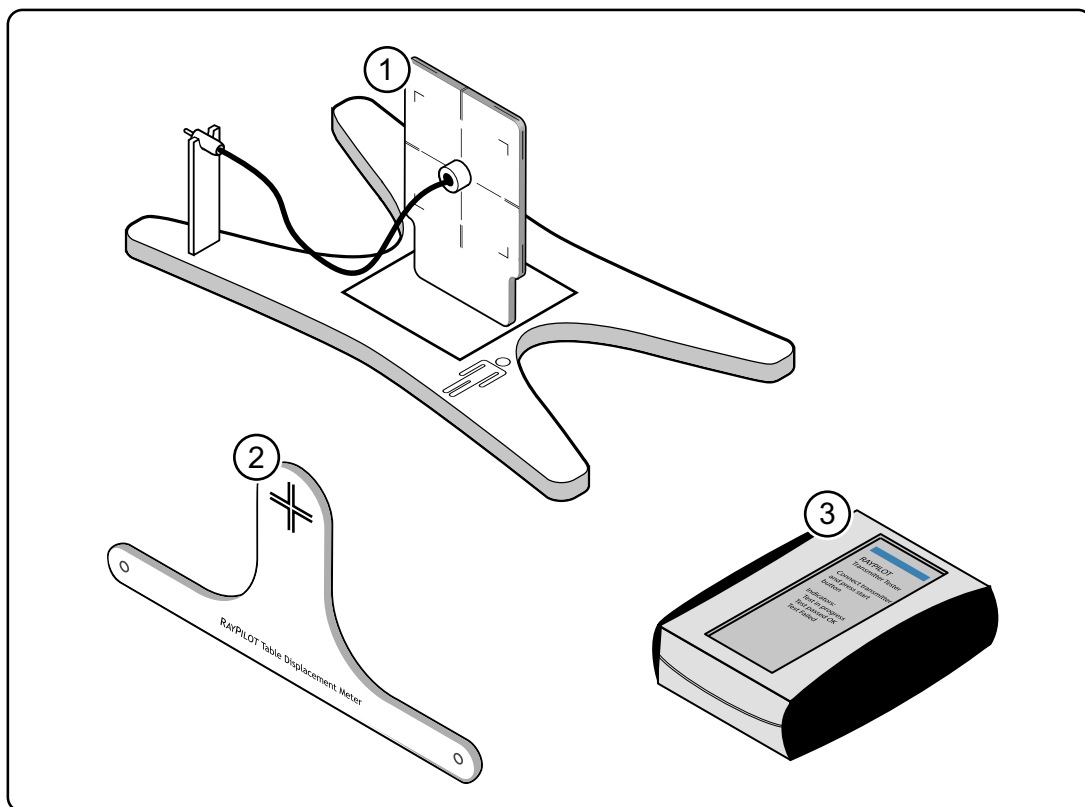

Figure 2 RayPilot accessories

No	Description	Part no
1	RayPilot quality control kit: <ul style="list-style-type: none"> <li>• QA tower</li> <li>• QA base plate</li> <li>• QC transmitter</li> </ul>	4005
2	RayPilot table displacement meter	4007
3	RayPilot transmitter tester	4006

Table 4 List of RayPilot accessories in figure 2

## 1.7 System Overview

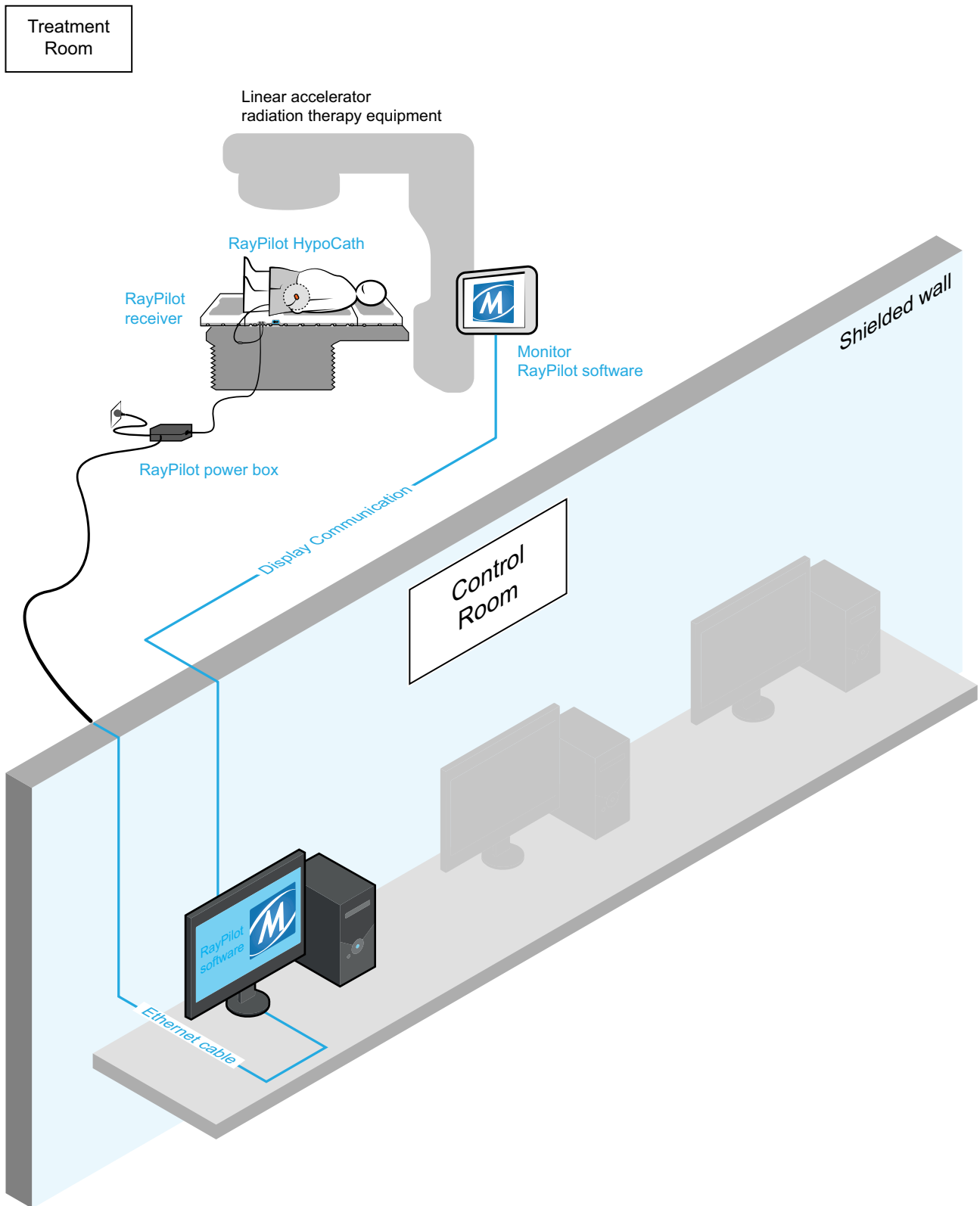

Figure 3 System overview

## 1.8 Multi Room Installation Overview

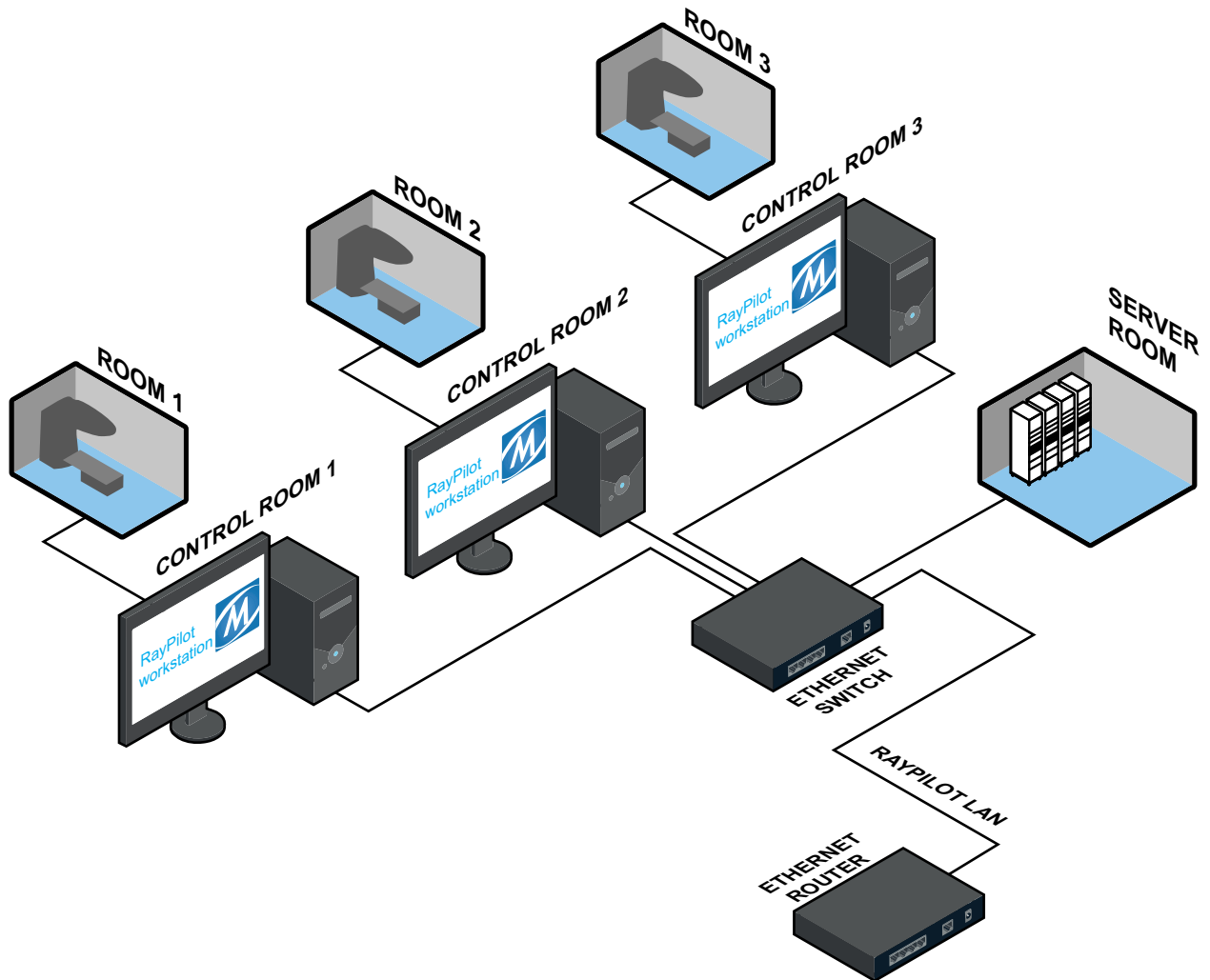

Figure 4 Multi room installation overview

## 1.9 RayPilot Software User Interface

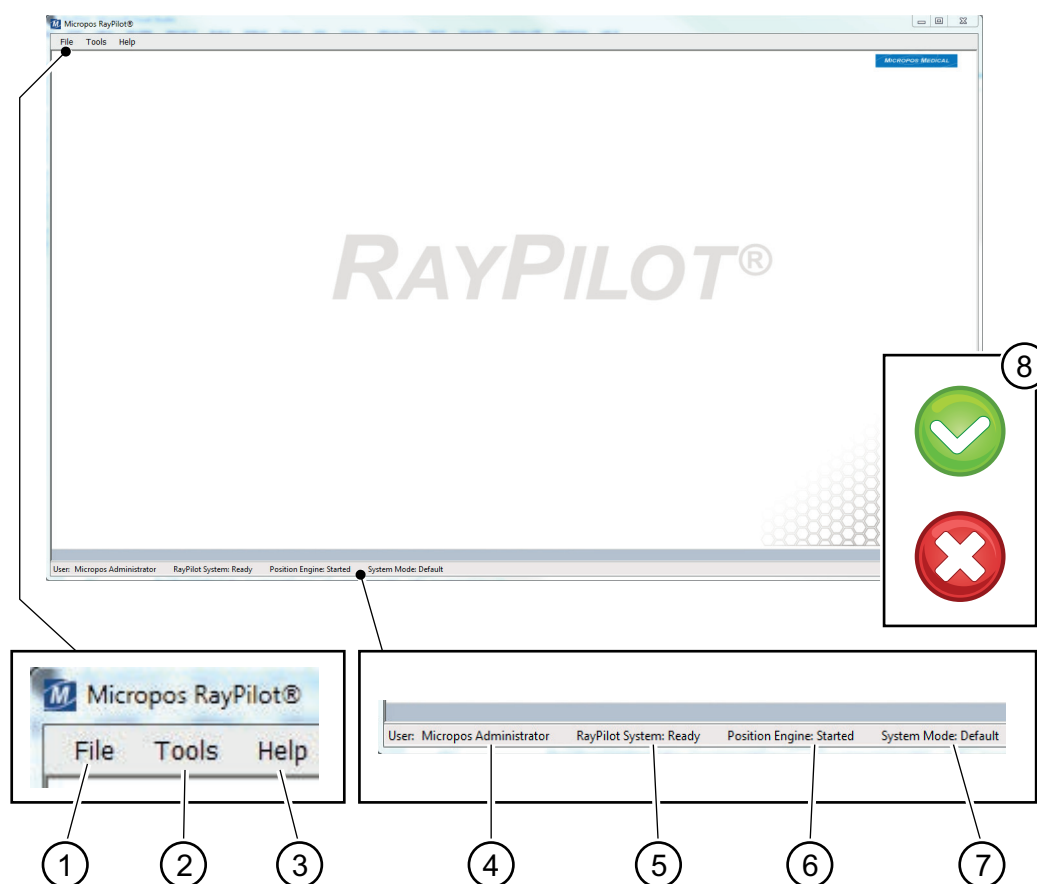

Figure 5 RayPilot software user interface

No	Function	Description
1	File menu	Start Session, Log In, Log Out and Exit
2	Tool menu	User Accounts, System Status, Measurement Volume 3D, Quality Control, Options, and Extensions
3	Help menu	Information regarding software
4	User role information	Administrator or Operator
5	RayPilot system status	Ready or Not ready
6	Position engine status	Initialized - Position engine is initialized Started - Position estimation is started Error - Error in the position engine
7	System mode information	Current screen
8	Measurement quality indicator	If green - System performance OK If red - System performance not OK, see 6.2 Error and Warning Messages If gray - Transmitter disconnected

Table 5 Functions in RayPilot software

---

### 1.9.1 Functions

- User login
- Patient database
- Add new patient
- HypoCath® transmitter monitoring during treatment
- Patient log
- Functional checks of the system
- Detection of interference from external sources
- Import treatment plan
- Automatic patient identification
- Initial patient setup guidance
- Automatic Beam Detection

#### Note!

The system continuously logs all usage and saves the information in a log file.

### 1.9.2 Positioning Mode

- **Standard table positioning**  
See 4.6 First Treatment with Standard Table Positioning and 4.8 Treatment with Standard Table Positioning.
- **Table positioning and image synchronization**  
See 4.7 First Treatment with Table Positioning and Image Synchronization and 4.9 Treatment with Table Positioning and Image Synchronization.

### 1.9.3 Software Access

All users of the system need to be authorized by the administrator. The software includes a function for registering new users and setting the user's permissions. There are two permission levels for users of the RayPilot software:

- **Administrator**  
A representative from Micropos Medical, or Micropos Medical certified, who is responsible for the maintenance of the system. The administrator has full access to all parts of the system. Micropos creates the first administrator at the clinic during installation.
- **Operator**  
Personnel who use the equipment clinically. Access is limited to those functions needed to perform treatment and daily quality control tests.

### 1.9.4 Automatic Patient Identification

Automatic Patient Identification functionality enables RayPilot to automatically open patient data stored in software based on the currently connected transmitter. This requires a matching procedure that is performed by the operator on the first treatment of every patient. On all following treatments, based on the matching between transmitter and patient data, RayPilot software automatically open previously stored patient data because the transmitter has a unique ID. Only one set of patient data can be matched to a specific transmitter at a time.

If warning messages appear, see 6.2.3 Communication Problem with Automatic Patient Identification.

---

### 1.9.5 Coordinates

All data is stored according to IEC 61217:2011 Radiotherapy equipment - Coordinates, movements and scales.

#### **Note!**

Visual data presentation in software, can be configured according to your requirements.

### 1.9.6 Measurement Quality Indicator

The measurement quality indicator is a function that indicates the positioning performance of the system. It turns red to warn for unreliable data. It warns for example if the transmitter is outside measurement volume, if the system is not connected properly or if there is an external disturbance, such as metal objects or incompatible fixation equipment, in the vicinity of the system. The measurement quality indicator is also warning if there is a mechanical failure or degradation in the system which influence the system performance.

### 1.9.7 Import Treatment Plan

With RayPilot software the patient treatment plan can be imported in DICOM-RT format. The patient treatment plan contains information about the patient and the treatment such as the number of treatment fractions, treatment energy.

#### **Note!**

The material in the receiver system affects the beam attenuation. Depending on the treatment, the user may want to take it into consideration in the dose plan.

### 1.9.8 Modes

The RayPilot software can be configured to be operated in different table positioning modes. Only an administrator can change modes before the treatment.

### 1.9.9 Control Panel on the RayPilot Receiver

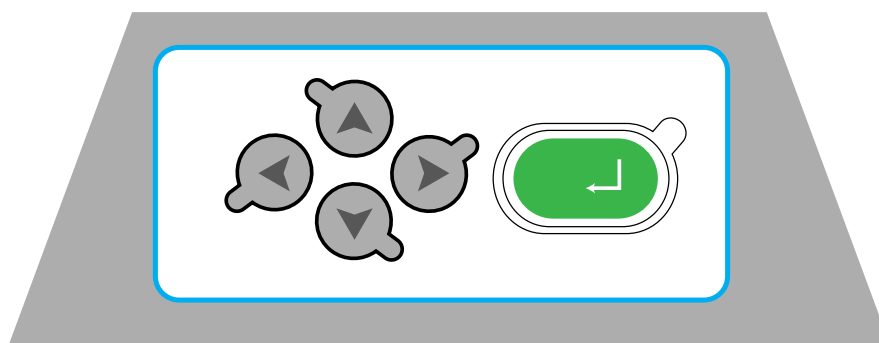

Figure 6 Control panel on the RayPilot receiver

The control panel on the RayPilot receiver can control the RayPilot software. Which button to use is shown on the screen.

---

### 1.9.10 Automatic Beam Detection

Automatic beam detection is an option that can be added to the RayPilot system. This functionality will enable the RayPilot system to automatically detect start and stop events of CBCTs (Cone Beam CT) with an energy of at least 125 kV as well as treatment beams with an energy of at least 6 MV.

## 1.10 Definitions

Definition	Description
LAT	Lateral direction
LNG	Longitudinal direction
VRT	Vertical direction
Transmitter	Transmitter referencing to the integrated transmitter part of the RayPilot HypoCath. The transmitter sends out a signal to the receiver.
Positioning measurements	All positioning measurements presented in the RayPilot software are in centimeters (cm) unless otherwise specified.
Positioning point	The tip of the HypoCath transmitter is the positioning point and is clearly visible on x-ray images such as CT scans used for dose planning.
Marker	Marker referencing to the integrated marker in the RayPilot ViewCath. The RayPilot ViewCath is used for simulating the same situation during treatment planning as with the RayPilot HypoCath during treatment. The marker in ViewCath has the same position as the transmitter tip in the RayPilot HypoCath.



---

## 2 Safety

### 2.1 Target Group

The target group for this information are medical physicists, radiation oncologists, and radiation technologists who work with radiation treatment of cancer patients.

### 2.2 Installation and Service

Installation, service, maintenance and repairs of the RayPilot system must be conducted by Micropos Medical personnel or the Micropos Medical authorized representatives.

The installation shall be performed so that mains plug is easy accessible.  
The RayPilot power box shall be installed and connected to an outlet with protective earth (100-240 VAC and 50/60 Hz). The power supply shall be installed far away from the treatment table.

### 2.3 Educational Requirements

The safety instructions in the relevant manuals require that personnel operating Micropos Medical products have the necessary education and training. Micropos Medical provides adequate training for the RayPilot system.

A good understanding of the language that the information is presented in is required, to make sure that these and other instructions can be understood and complied with.

### 2.4 Warnings

---



#### **Warning!**

Make sure that the system is connected to supply mains with protective earth. This will help prevent an electric shock. An electric shock can cause injury to personnel and/or damage to the equipment.

---



#### **Warning!**

Do not modify or open the products. This can cause injury to personnel and/or damage to the equipment.

---



### **Warning!**

Use of accessories, transducers and cables other than those specified or provided by the manufacturer of this equipment could result in increased electromagnetic emissions or reduced electromagnetic immunity of this equipment and result in improper operation. This can cause injury to personnel and/or damage to the equipment.

---



### **Warning!**

Use of this equipment adjacent to or stacked with other equipment should be avoided because it could result in improper operation. If such use is necessary, this equipment and the other equipment should be observed to verify that they are operating normally or it can cause injury to personnel and/or damage to the equipment.

---



### **Warning!**

Portable RF communications equipment (including peripherals such as antenna cables and external antennas) should be used no closer than 30 cm (12 inches) to any part of the receiver, including cables specified by the manufacturer. Otherwise, degradation of the performance of this equipment could result. This will help prevent injury to personnel and/or damage to the equipment.

---

## **2.5 Cautions**

---



### **Caution!**

Make sure that the cables are lying unimpeded outside the irradiation field, and ensure that the couch and gantry can be moved freely. This will help prevent damage to the equipment.

---



### **Caution!**

Make sure that radiation does not occur in area beyond line: "No radiation beyond this line" (that is written on top of the RayPilot receiver). Radiation beyond that may effect the RayPilot receiver system electronics and cause damage to the equipment.

---



### **Caution!**

Make sure that the correct transmitter, couch displacement, and patient data is inserted into the system so that correct patient setup data can be loaded and verified according to clinical routine.

---



### Caution!



Make sure that the correct transmitter offset to isocentre is used throughout the course of treatment, in order to have a correct patient setup guidance.

## 2.6 Contraindication

Do not use the RayPilot system on patients that weigh more than 135 kg.

## 2.7 Symbols on the Products

Symbol	Description
	<b>Operating instructions</b> Consult instructions for use
	<b>Protective earth (ground)</b>
	<b>TYPE BF APPLIED PART</b> To identify a type BF applied part complying with IEC 60601-1 NOTE 1 - B = Body NOTE 2 - F = Floating applied part
	<b>Non-ionizing electromagnetic radiation</b> To indicate generally elevated, potentially hazardous, levels of non-ionizing radiation, or to indicate equipment or systems e.g. in the medical electrical area that include RF transmitters or that intentionally apply RF electromagnetic energy for diagnosis or treatment
	<b>Date of manufacture</b>
	<b>Manufacturer</b>
	<b>Serial number of device</b>
	<b>Item number of device</b>
	<b>Device shall be recycled</b>

Symbol	Description
	Prescription use only
	Unique device identifier

## 2.8 MR Unsafe



Figure 7 MR unsafe symbol

The RayPilot HypoCath is MR unsafe. Keep it outside the MRI scanner room.

## 2.9 Treatment Duration

If the patient treatment for any reason is prolonged to more than 30 days, the RayPilot HypoCath needs to be replaced.





## 2.10 Security

This chapter contains instructions on how to keep the RayPilot software secure.

Do not under any circumstances perform any of the following without consulting with Micropos Medical:





- Install any software on the RayPilot workstation.
- Deactivate Microsoft Defender Antivirus\*.
- Deactivate Microsoft Defender Firewall\*\*.
- Modify the hardware configuration.
- Modify the RayPilot software configuration.

If Microsoft Defender Antivirus has detected malware on the RayPilot workstation, the user will receive a message in Windows Security. We recommend the user to run a Microsoft Defender Offline Scan by performing the following steps:

1. Disconnect the RayPilot workstation from the network.
2. Select Start , and then select Settings  > Update & Security  > Windows Security  > Virus & threat protection .
3. On the Virus & threat protection screen, under Current threats, select Scan options.

- 
4. Select Microsoft Defender Offline Scan, and then select Scan now.

When the scan has completed, the user can access the results by performing the following steps:

1. Select Start , and then select Settings  > Update & Security  > Windows Security  > Virus & threat protection .
2. On the Virus & threat protection screen in Windows 10, under Current threats, select Scan options, and then select Protection history.

The scan results must be communicated with Micropos Medical to assess if the RayPilot system can be reinstated into clinical use again.

\* Microsoft Defender Antivirus is a component of Microsoft Windows that delivers real-time protection against software threats like viruses, malware, and spyware.

\*\* Microsoft Defender Firewall is a program that protects against threats that can enter the workstation over the network.



---

# 3 Settings

## 3.1 Sign In RayPilot Software

### 3.1.1 Description

#### Task

The task is to log in on RayPilot Software.

#### Task interval

Pre-treatment.

#### Conditions

User account has been created.

### 3.1.2 Instructions

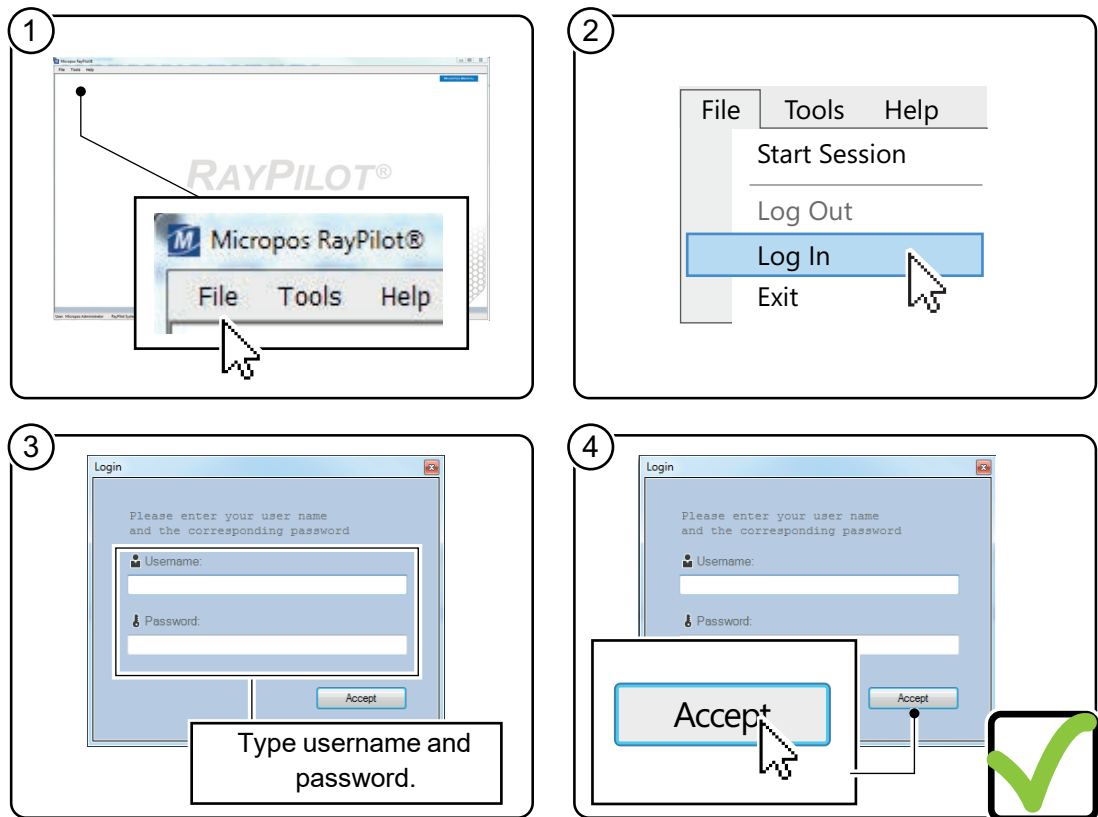

Figure 8 Sign-In instructions

## 3.2 Administrator's Function

### 3.2.1 Description

#### Task

The task is to use various administrator functions.

#### Task interval

Pre-treatment.

#### Conditions

User is signed in to RayPilot software, see 3.1 Sign In RayPilot Software.

User has administrator permission level. For more information, see 1.9.3 Software Access.

### 3.2.2 Add New User

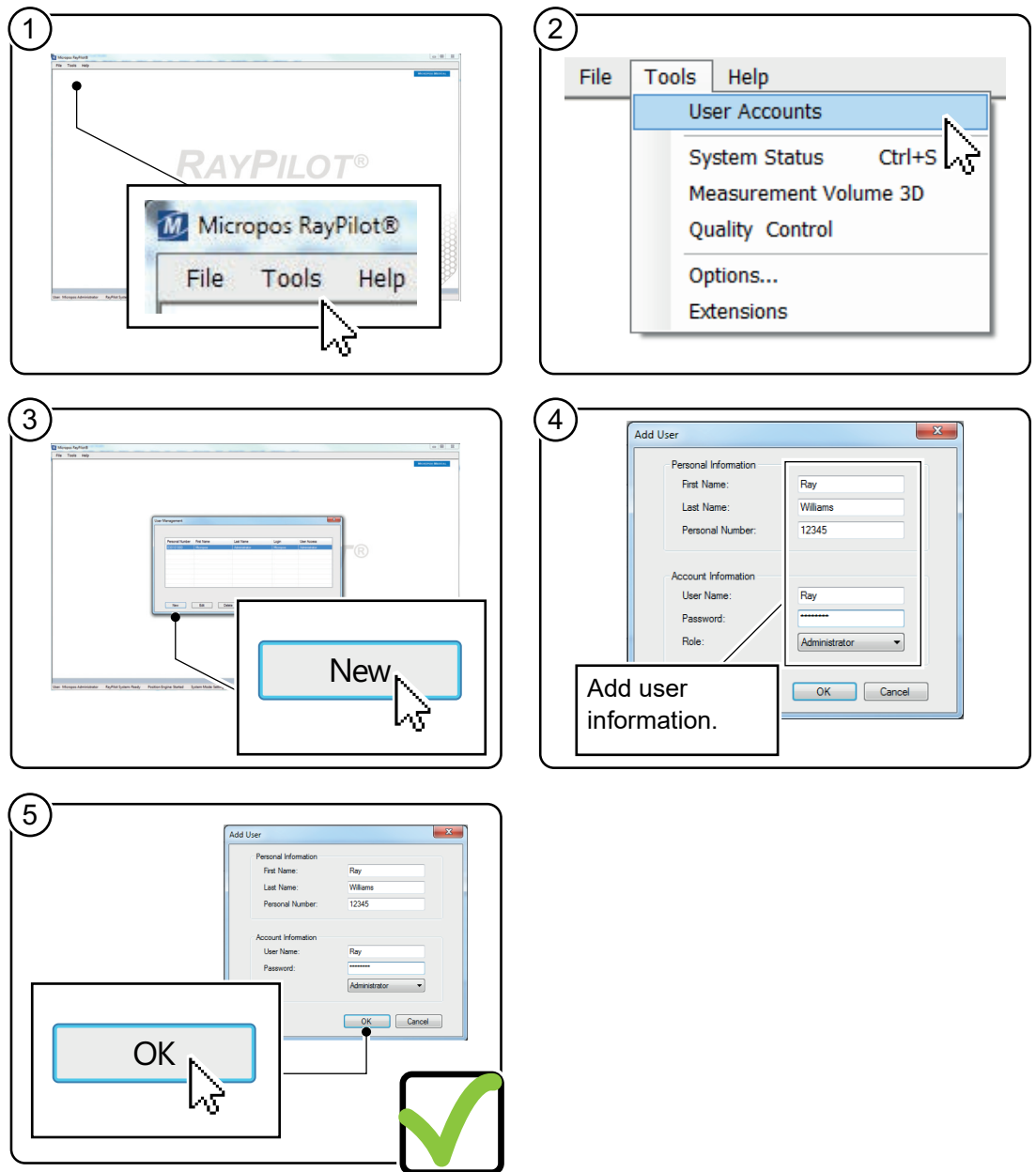

Figure 9 Instructions for adding new user

### 3.2.3 Edit User

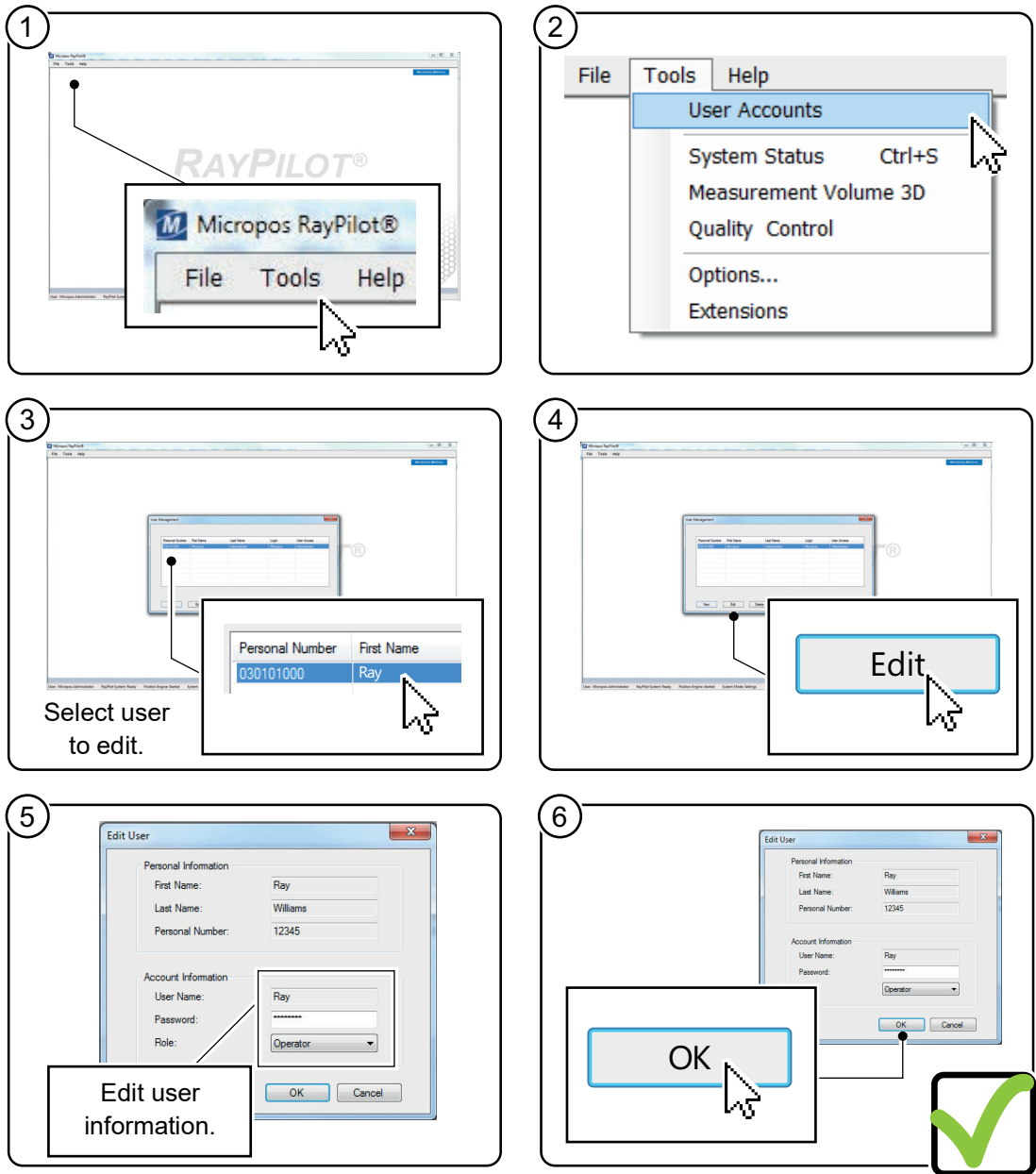

Figure 10 Instructions for editing user

### 3.2.4 Delete User

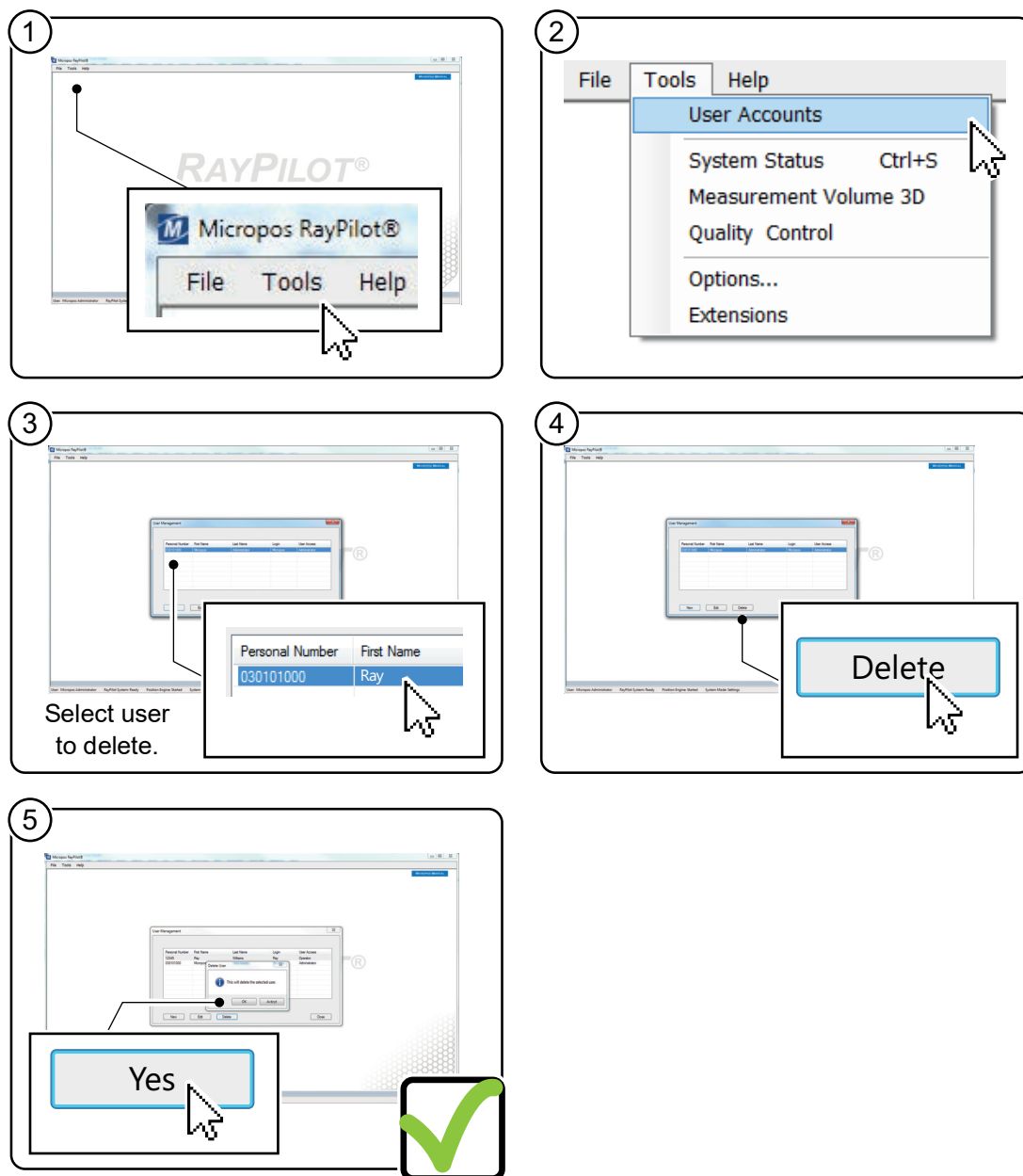

Figure 11 Instructions for deleting user

## 3.3 Operator's Function

### 3.3.1 Description

#### Task

The task is to use various operator's functions.

## Task interval

Pre-treatment.

## Conditions

User is signed in to RayPilot software, see 3.1 Sign In RayPilot Software.

### 3.3.2 Add New Patient from DICOM-RT Database

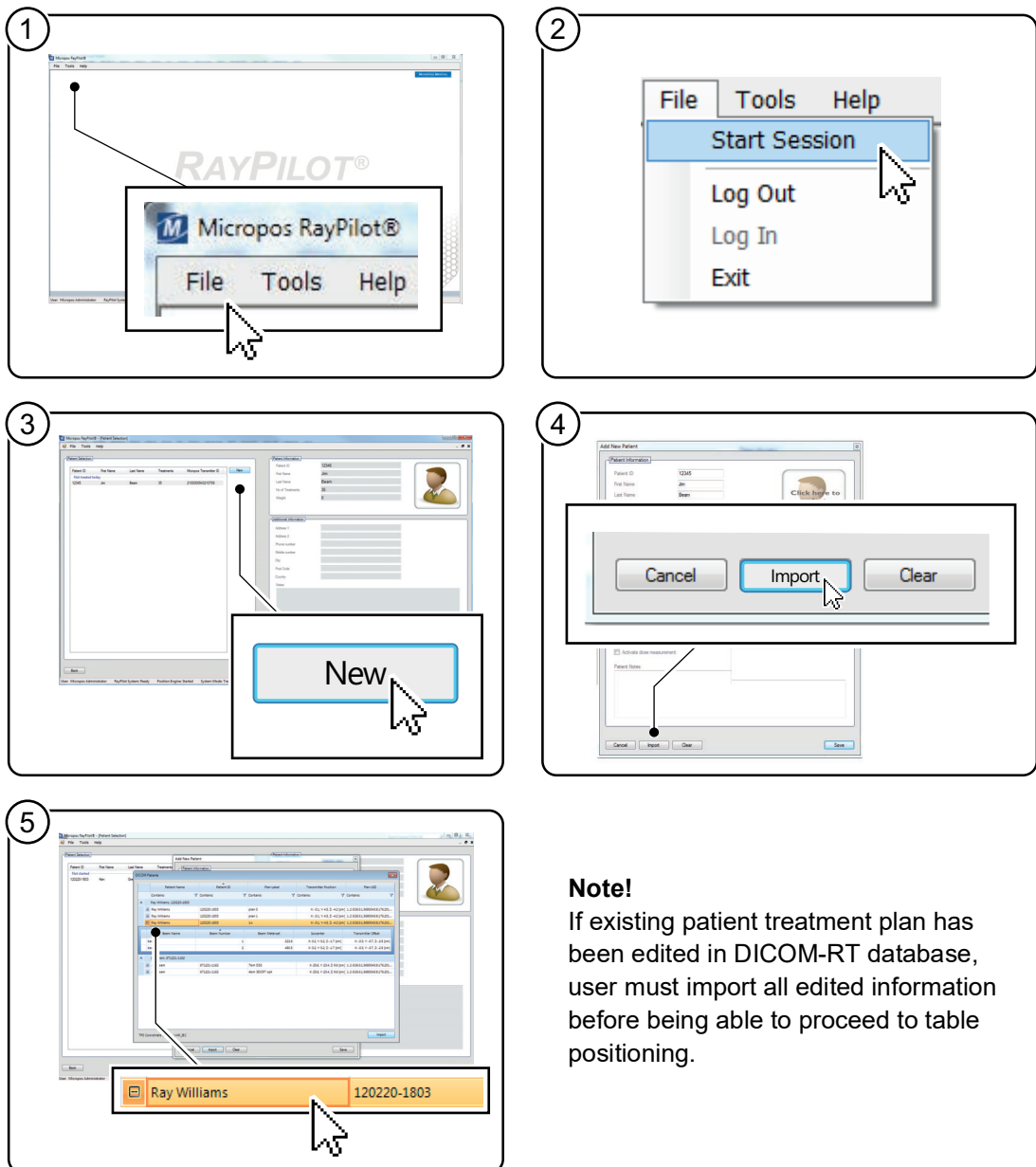

Figure 12 Instructions for adding new patient from DICOM – RT database (step 1-5)

## Note!

If new patient treatment plan has been created in DICOM-RT database, user can choose between adding new treatment plan or proceed with old treatment plan.

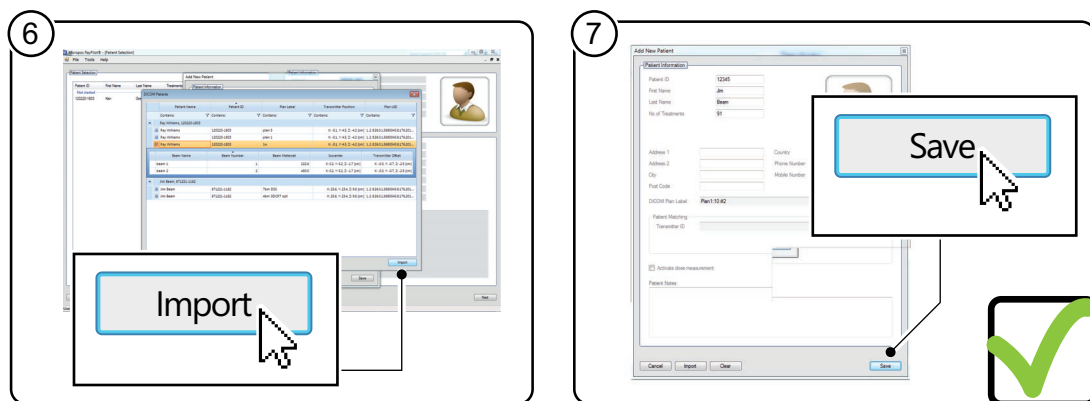

Figure 13 Instructions for adding new patient from DICOM – RT database (step 6-7)

### 3.3.3 Add New Patient without DICOM-RT database

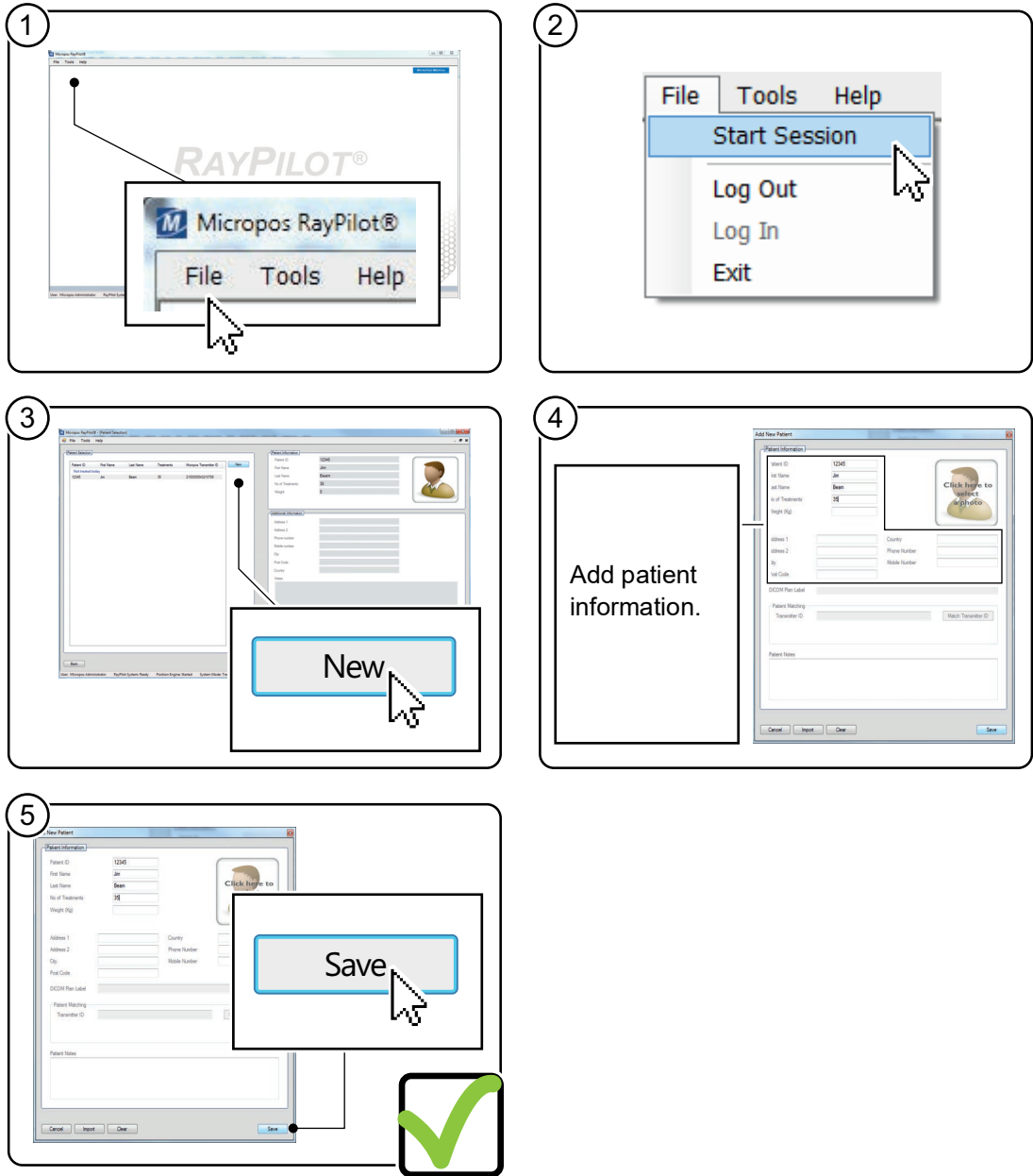

Figure 14 Instructions for adding new patient without data from DICOM – RT database

### 3.3.4 Edit Patient Information

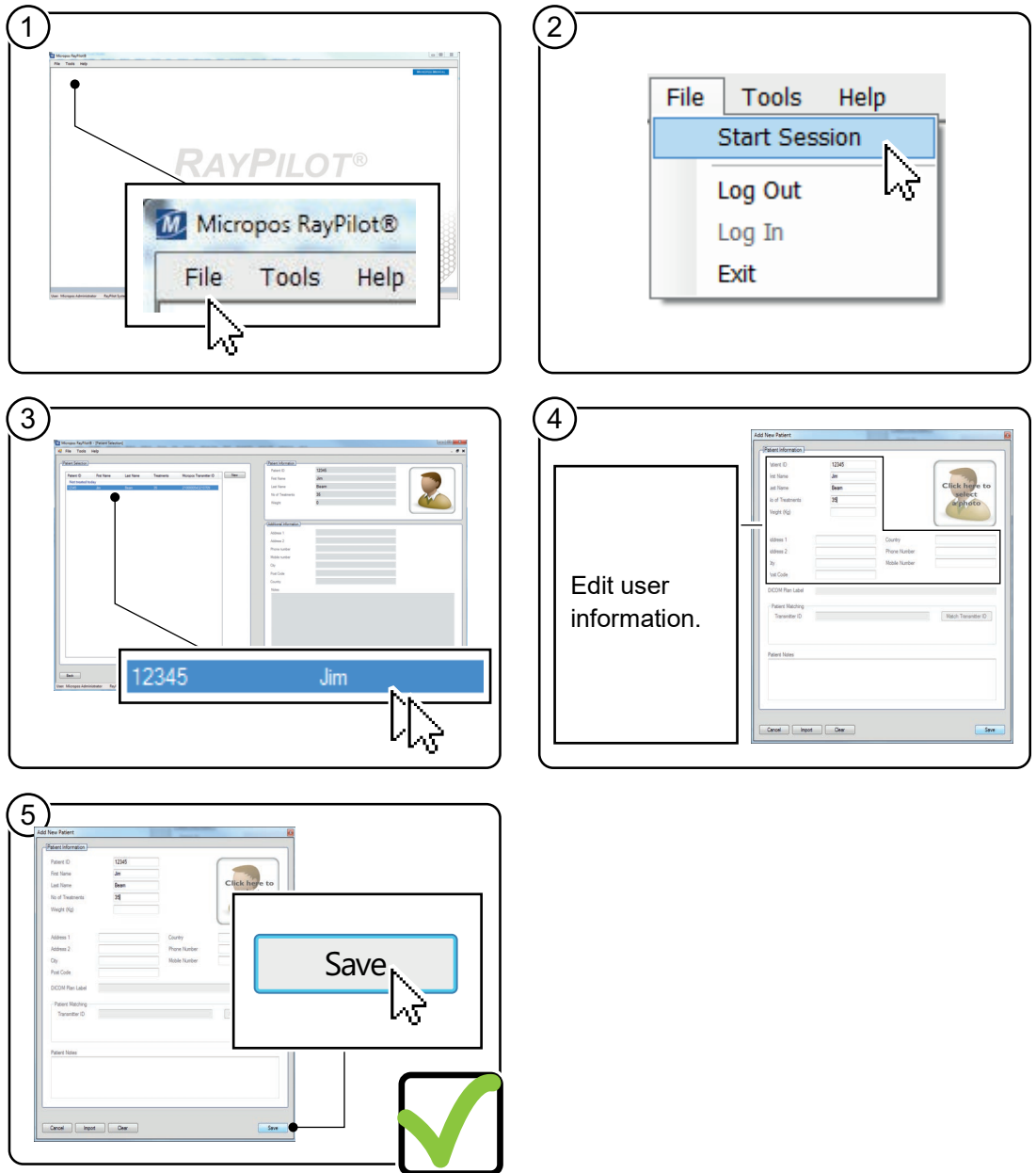

Figure 15 Instructions for editing patient information



---

# 4 Treatment

## 4.1 Set Up Equipment

### 4.1.1 Description

#### Task

The task is to set up RayPilot receiver.

#### Task interval

Pre-treatment.

#### Conditions

RayPilot receiver has been calibrated during first installation by Micropos Medical representative.

2 Index bars.

### 4.1.2 Instructions

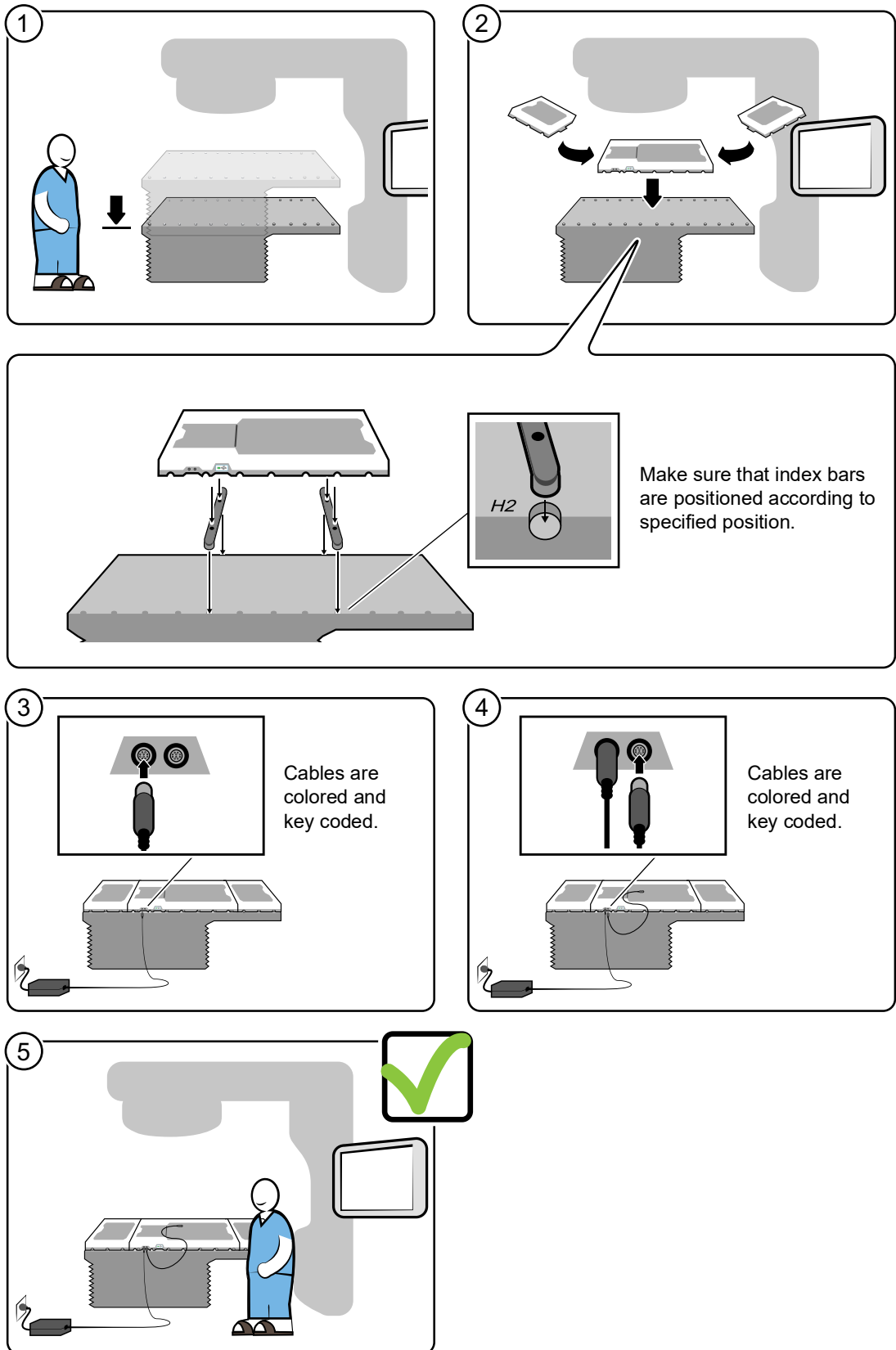

Figure 17 Instructions for setting up equipment

---

## 4.2 Daily Quality Control

### 4.2.1 Description

#### Task

The task is to verify RayPilot receiver system functions.

#### Task interval

Pre-treatment.

#### Conditions

RayPilot accessories are needed for this task, see 1.6 RayPilot Accessories.

Equipment is set up, see 4.1 Set Up Equipment.

User is signed in to RayPilot software, see 3.1 Sign In RayPilot Software.

## 4.2.2 Instructions

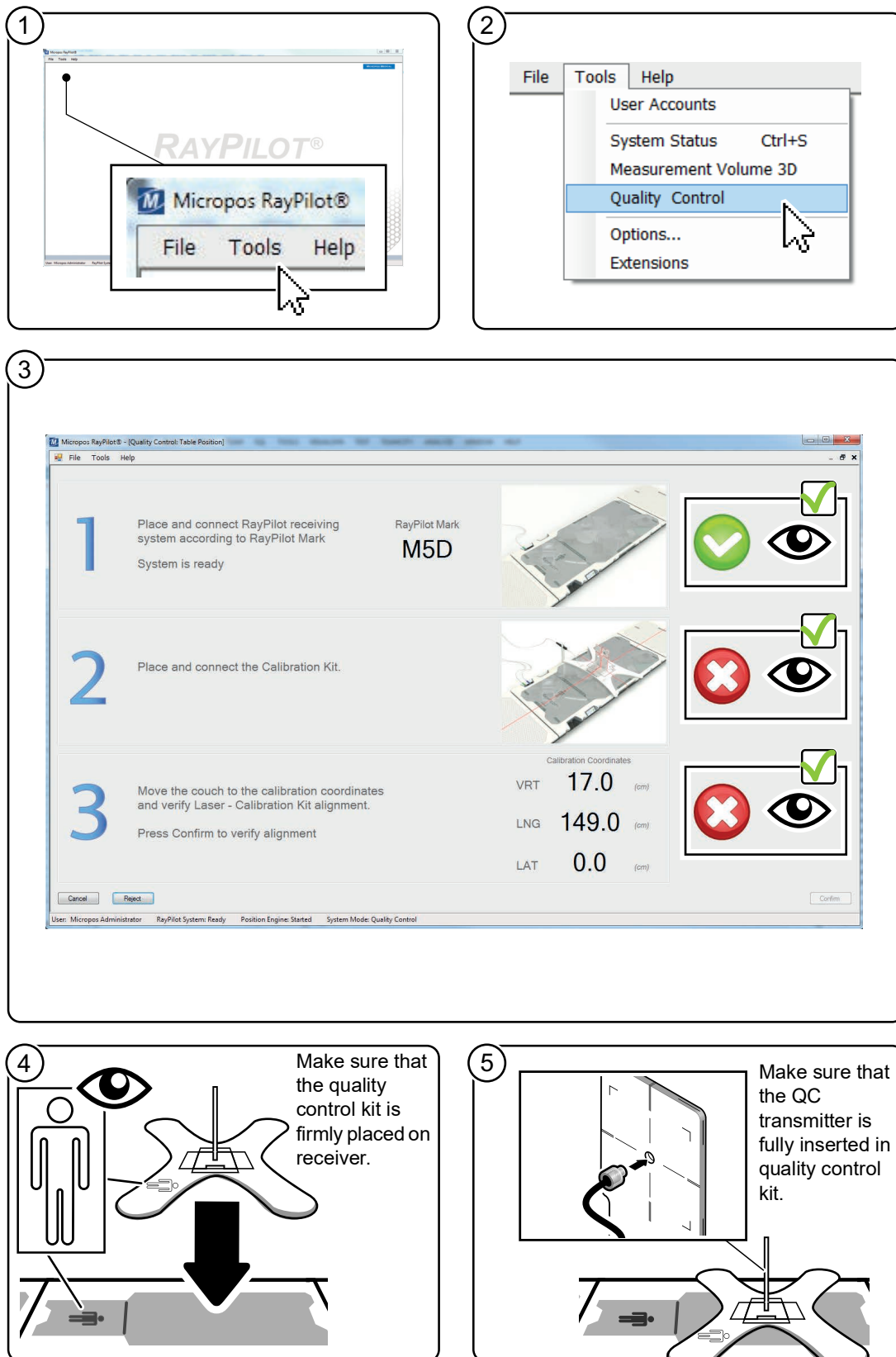

Figure 18 Instructions for daily quality control (step 1-5)

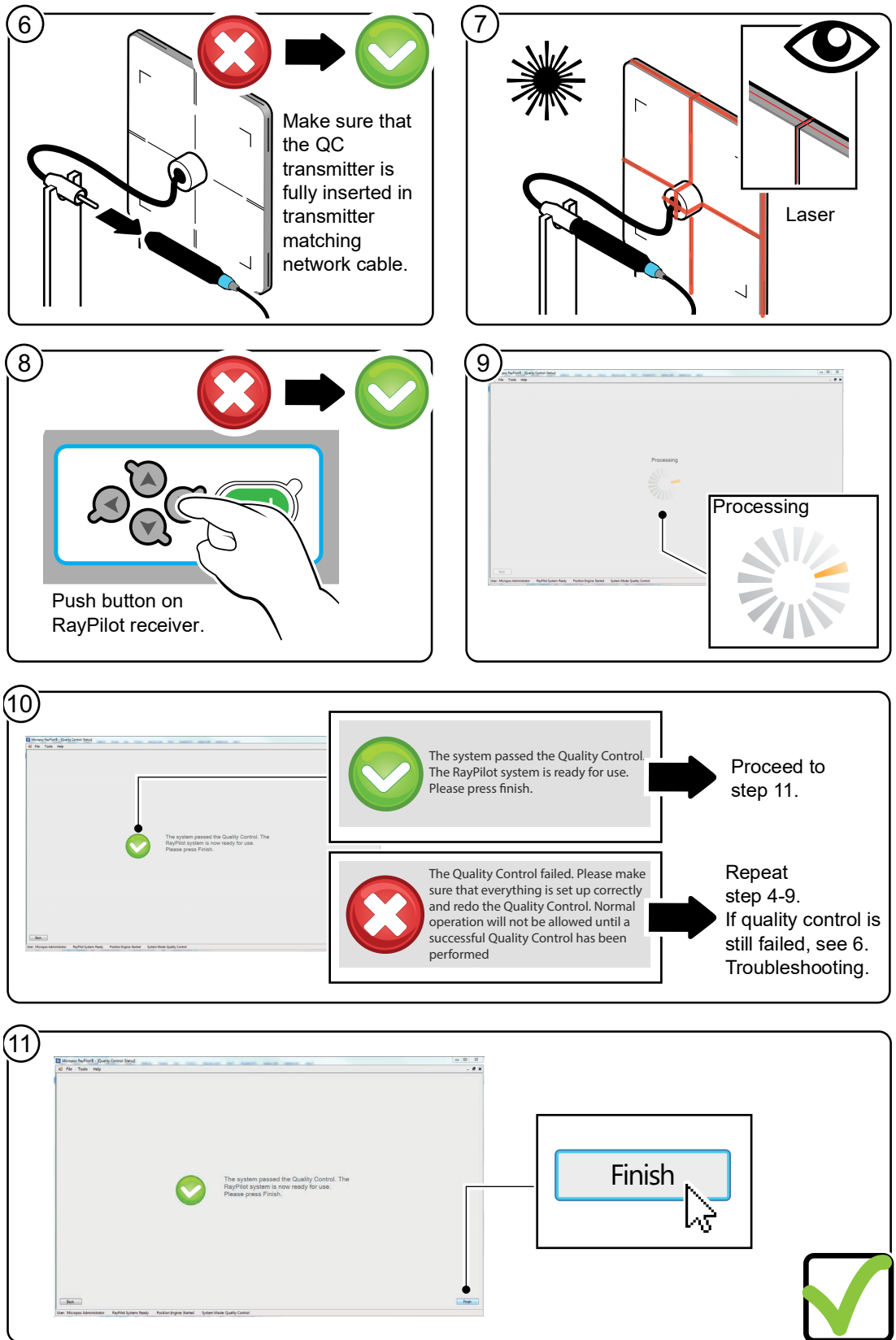

Figure 19 Instructions for daily quality control (step 6-11)

---

## 4.3 Add Patient Transmitter Displacement

### 4.3.1 CT Scan

Before treatment, the patient will undergo a CT scan for treatment planning. The RayPilot HypoCath or the RayPilot ViewCath must be inserted before this CT scan.

#### Note!

The thickness of the CT scans affects the accuracy in determining the position of the transmitter tip in relation to the isocentre during the treatment.

### 4.3.2 Transmitter Displacement

When the RayPilot HypoCath (or RayPilot ViewCath) is inserted into the prostatic urethra, the position of the transmitter tip (or the marker), in relation to the isocentre, is called transmitter displacement. Identify the coordinate of the transmitter tip or the marker in the images, and add the position to the dose plan. It can then be imported automatically with the plan. The transmitter displacement can also be inserted manually in the RayPilot software. The position to mark in each direction (LAT, LNG, VRT) is the center of the transmitter tip or the marker. The position shall be named as “RP transmitter”.



Figure 20 Sketch of RayPilot HypoCath

The position can be marked in the treatment planning system using one of the following methods:

- **Create a point of interest**  
The user can digitize a point of interest (used in, for example, dose planning systems Oncentra, RayStation and Pinnacle). The point is stored in the RT structure set.
- **Create a dose reference point**  
The user can digitize a dose reference point that will be imported in the RayPilot Software as transmitter position (used in, for example, the dose planning system Eclipse). The point is stored in the RT plan.
- **Create a contour shape**  
The user can digitize the point with the use of small contours, creating a Region of interest (used in, for example, dose planning system Monaco). When creating the contour a brush (or some predefined contour shape) can be used. The best practice to position the contour is to zoom in as much as practical (typically to create a structure of 1 mm, the placement of the contour is much more precise in this way).

---

RayPilot Software uses the calculated contours' centre points (centre of mass) and uses them for the position.

The transmitter stability in the target throughout the course of treatment influences the transmitter displacement. Make sure the RayPilot HypoCath is retracted until feeling resistance against the bladder wall, and fixed according to clinical procedure at the urethra opening.

**Note!**

If the offset is not taken from the CT image set and marked in the treatment planning step in the first treatment, see 4.7.4 Patient Set Up Guidance with Image Synchronization.

### 4.3.3 Description

#### Task

The task is to add transmitter displacement.

#### Task interval

Pre-treatment.

#### Conditions

Equipment is set up, see 4.1 Set Up Equipment.

User is signed in to RayPilot software, see 3.1 Sign In RayPilot Software.

Patient added to database, see 3.3.2 Add New Patient from DICOM Database.

### 4.3.4 Instructions

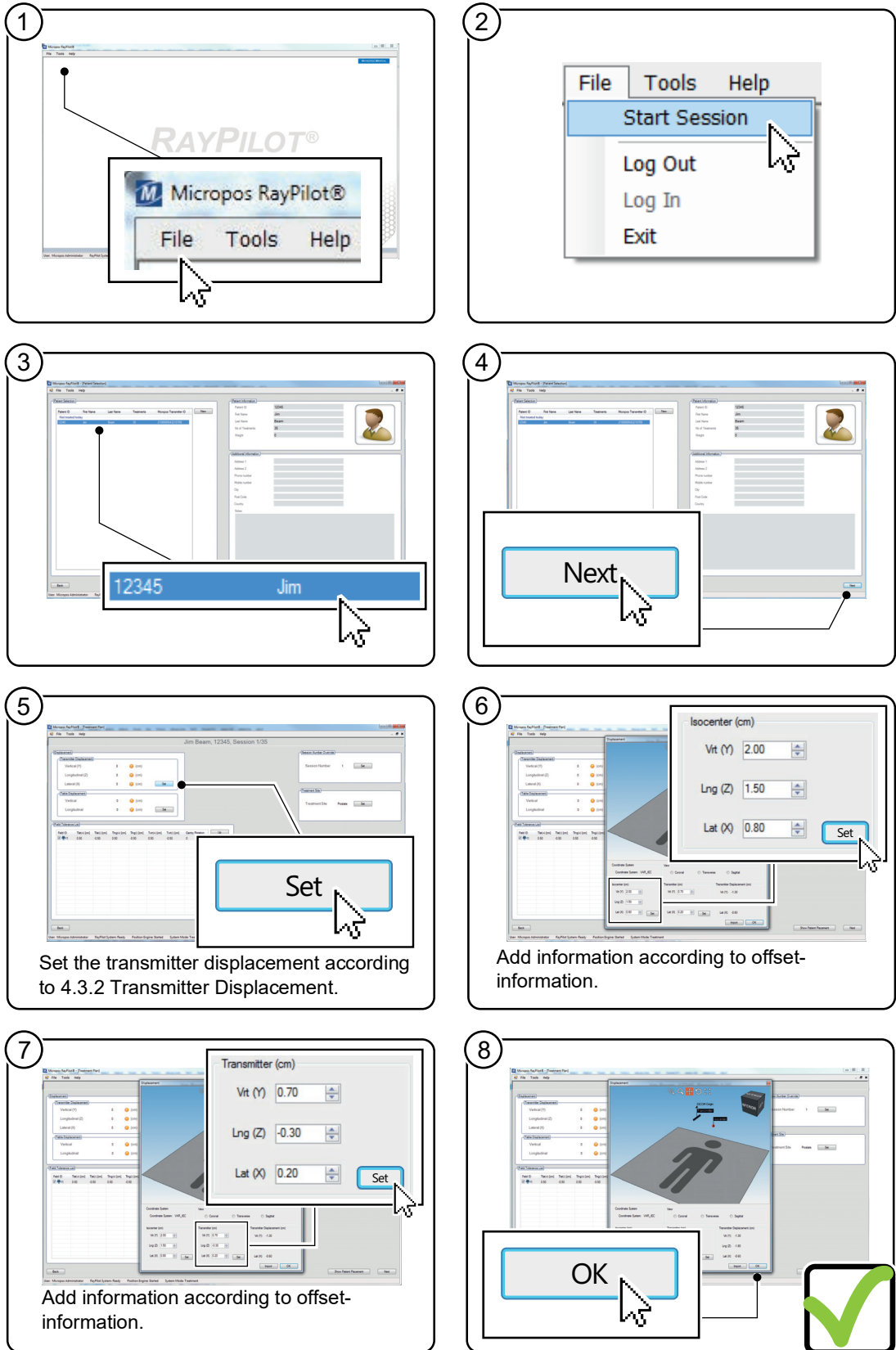

Figure 21 Instructions for adding patient transmitter displacement

---

## 4.4 Add Field Tolerance Parameters

### 4.4.1 Tolerance Parameters

Set tolerance parameters to make sure that the target is within the defined treatment volume. These tolerance parameters are called Left, Right, Superior, Inferior, Anterior and Posterior and specifies the thresholds along each axis. If the transmitter moves out of these tolerance parameters, a warning message will appear on the monitor.

The Planner select the parameters for each patient during treatment planning.

### 4.4.2 Description

#### Task

The task is to add field tolerance parameters.

#### Task interval

Pre-treatment.

#### Conditions

Equipment is set up, see 4.1 Set Up Equipment.

User is signed in to RayPilot software, see 3.1 Sign In RayPilot Software.

Patient added to database, see 3.3.2 Add New Patient from DICOM Database.

Transmitter displacement information has been added, see 4.3 Add Patient Transmitter Displacement.

### 4.4.3 Instructions

**1**

**2**

**3**

**4**

**5**

**6**

**7**

**8**

**Note!**  
Click on the OK-button to save field tolerance parameters as template.

Figure 22 Instructions for adding field tolerance parameters

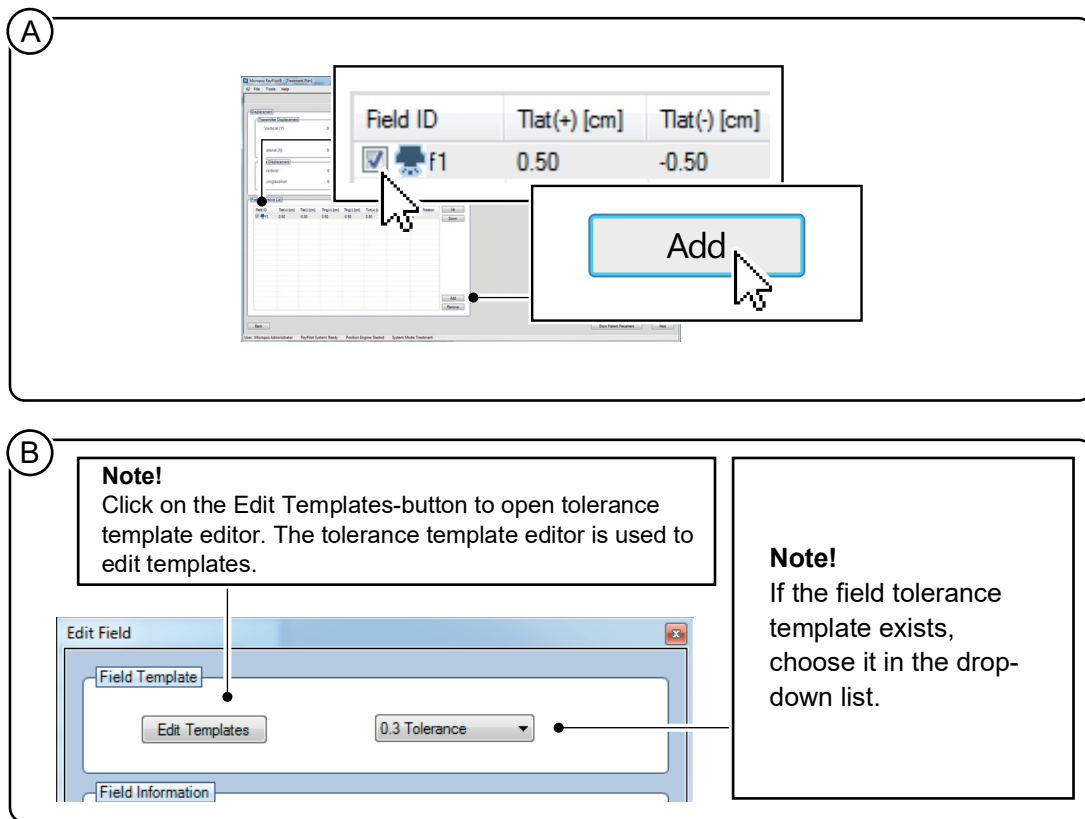

Figure 23 Notes for editing field tolerance parameters

## 4.5 Match Patient to Transmitter ID

### 4.5.1 Description

#### Task

The task is to match the patient to a transmitter ID.

#### Task interval

Pre-treatment.

#### Conditions

Equipment is set up, see 4.1 Set Up Equipment.

User is signed in to RayPilot software, see 3.1 Sign In RayPilot Software.

Patient added to database, see 3.3.2 Add New Patient from DICOM Database.

Patient with inserted RayPilot HypoCath, see RayPilot HypoCath instructions for use.

## 4.5.2 Match Transmitter ID in Control Room

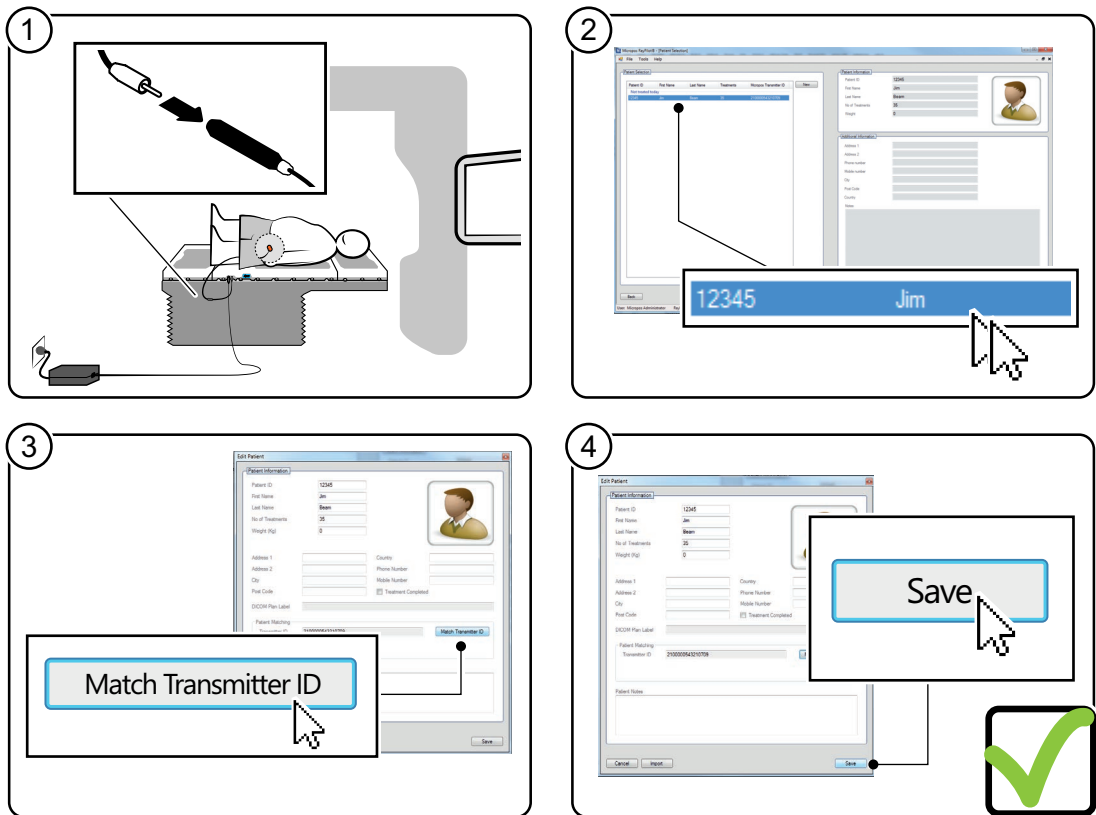

Figure 24 Instructions for matching transmitter ID in control room

### 4.5.3 Match Transmitter ID in Treatment Room

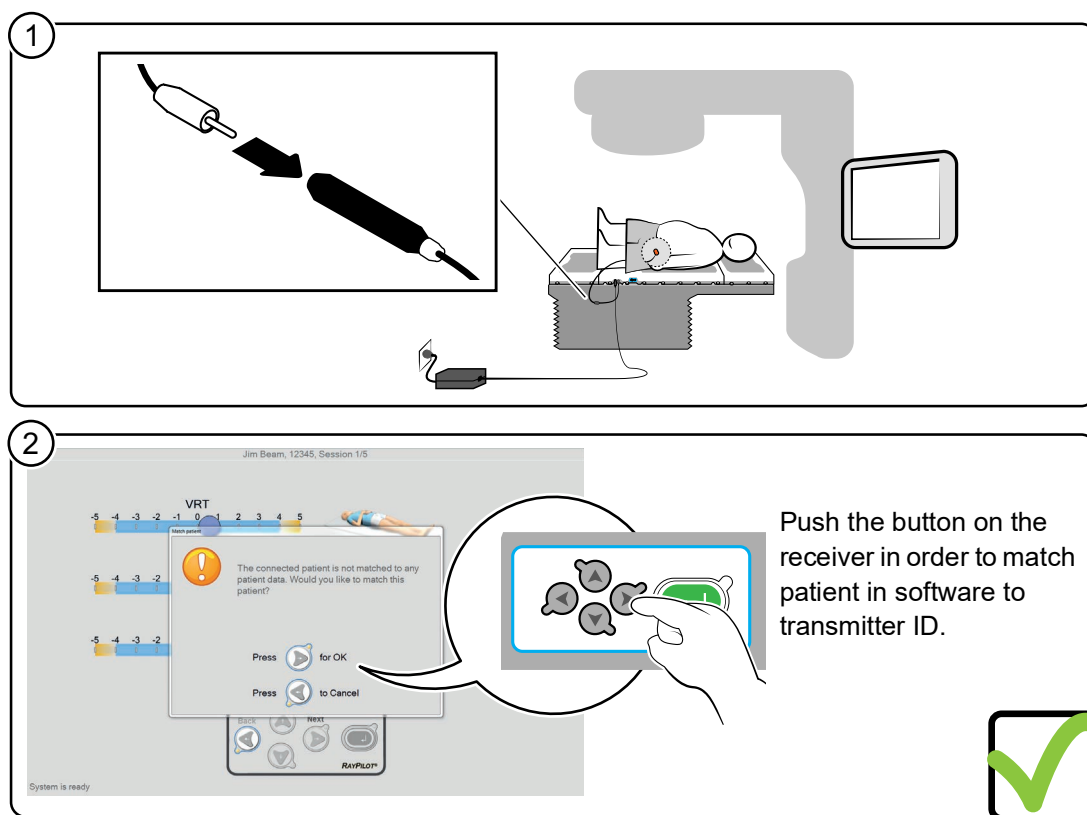

Figure 25 Instructions for matching transmitter ID in treatment room

## 4.6 First Treatment with Standard Table Positioning

### 4.6.1 Description

#### Task

The task is to perform patient treatment.

#### Task interval

During treatment.

#### Conditions

Equipment is set up, see 4.1 Set Up Equipment.

User is signed in to RayPilot software, see 3.1 Sign In RayPilot Software.

Patient added to database, see 3.3.2 Add New Patient from DICOM Database.

Daily control has been performed, see 4.2 Daily Quality Control.

Transmitter displacement information has been added, see 4.3 Add Patient Transmitter Displacement.

Field tolerance parameters has been added, see 4.4 Add Field Tolerance Parameters.

Transmitter ID and patient are matched, see 4.5 Match Patient to Transmitter ID.

## 4.6.2 Table Displacement and Patient Placement

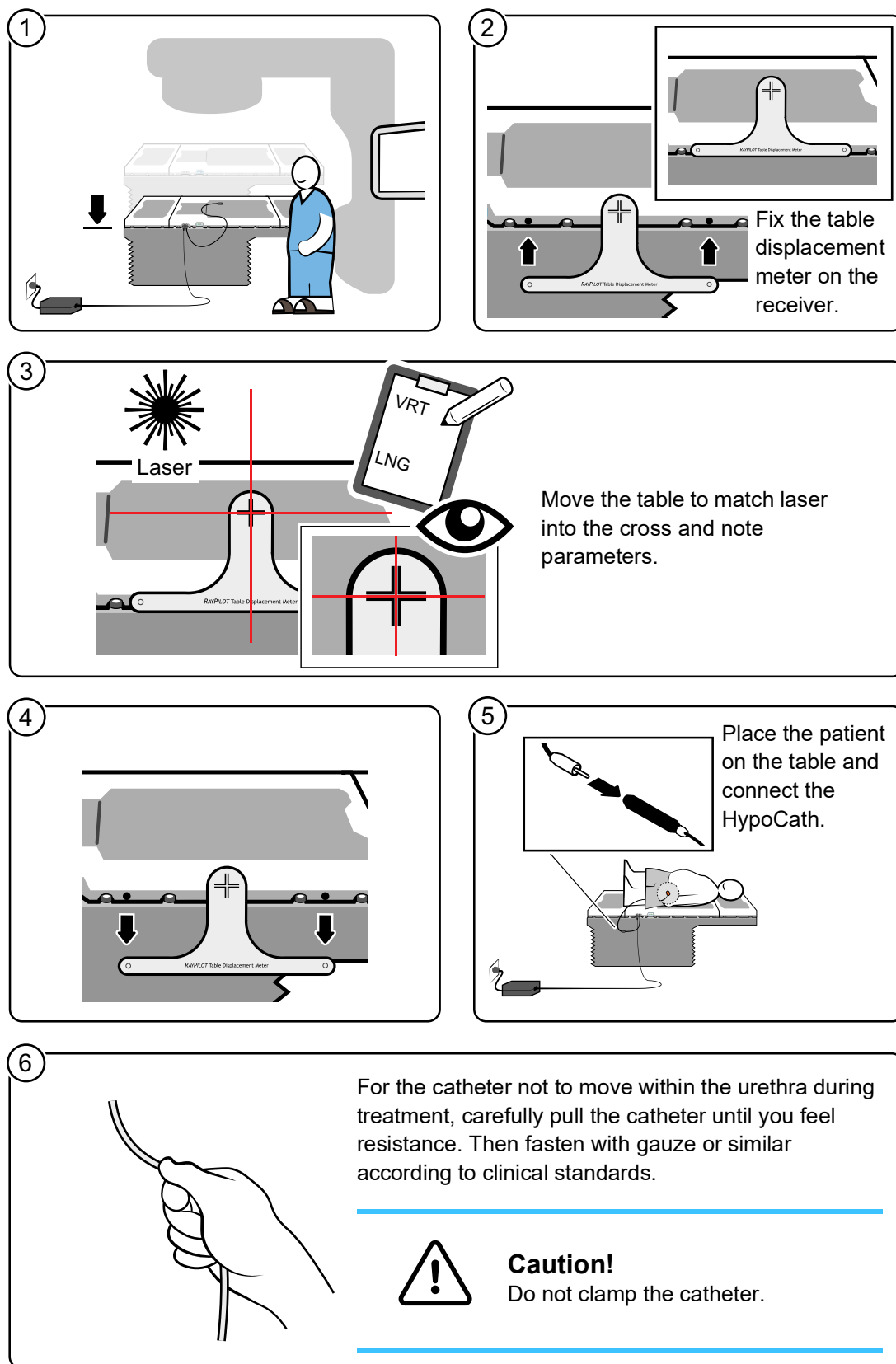



Figure 26 Instructions how to perform table displacement measurement (step 1-6)

7



The connected patient is not matched to any patient data. Would you like to match this patient?

Match the transmitter ID with the patient in software. See 4.5 Match Patient to Transmitter ID.

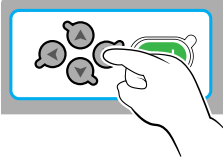

8

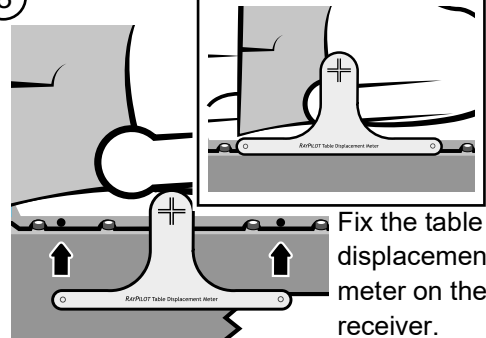

Fix the table displacement meter on the receiver.

9

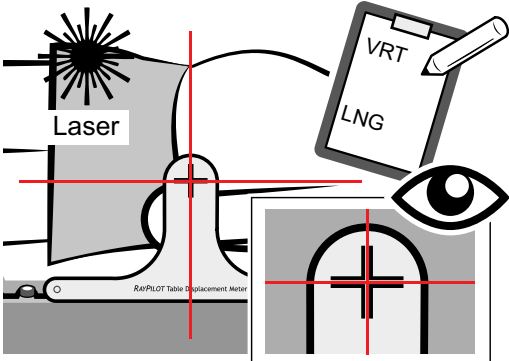

Move the table to match laser into the cross and note parameters.

10

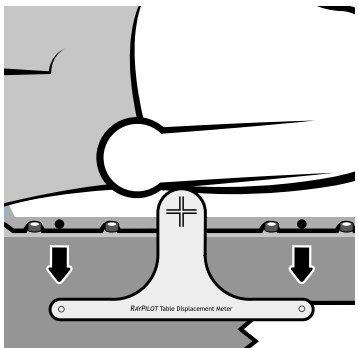

11

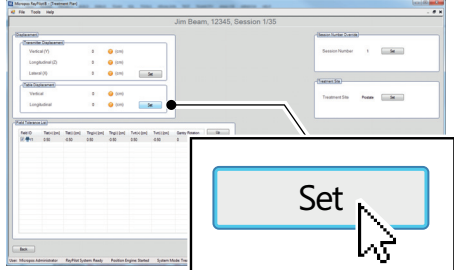

Insert the table displacement values received in step 2-10.

12

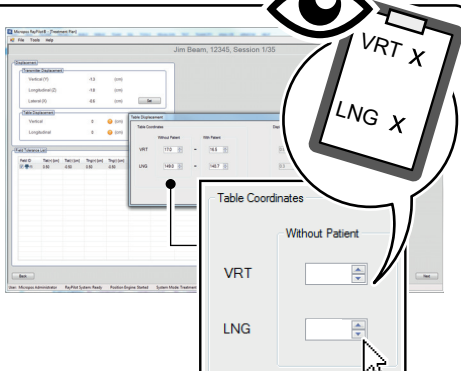

VRT X  
LNG X

Without Patient

VRT

LNG

13

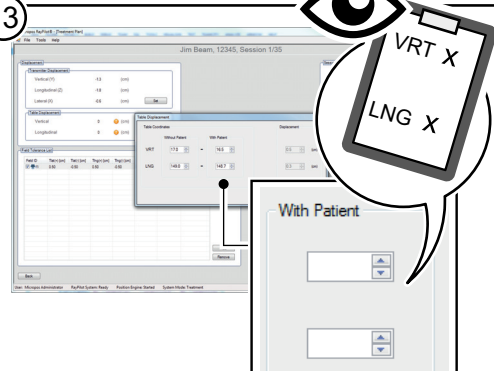

VRT X  
LNG X

With Patient

Figure 27 Instructions how to perform table displacement measurement (step 7-13)

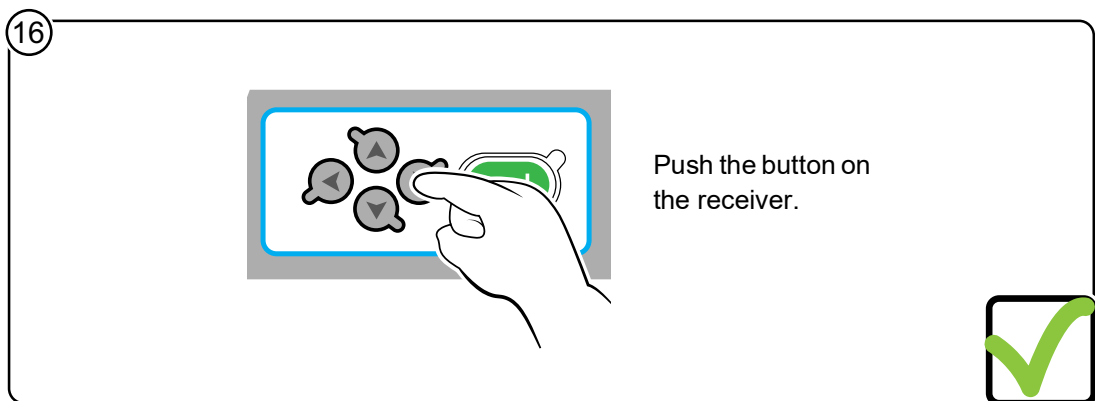
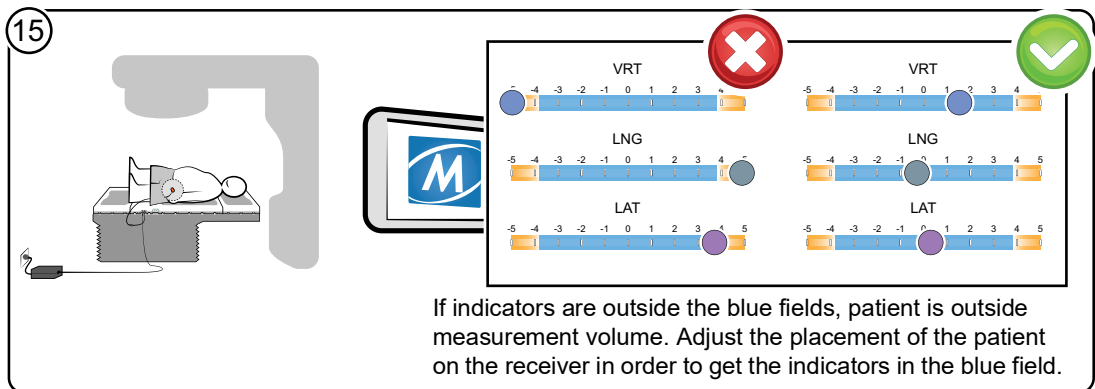
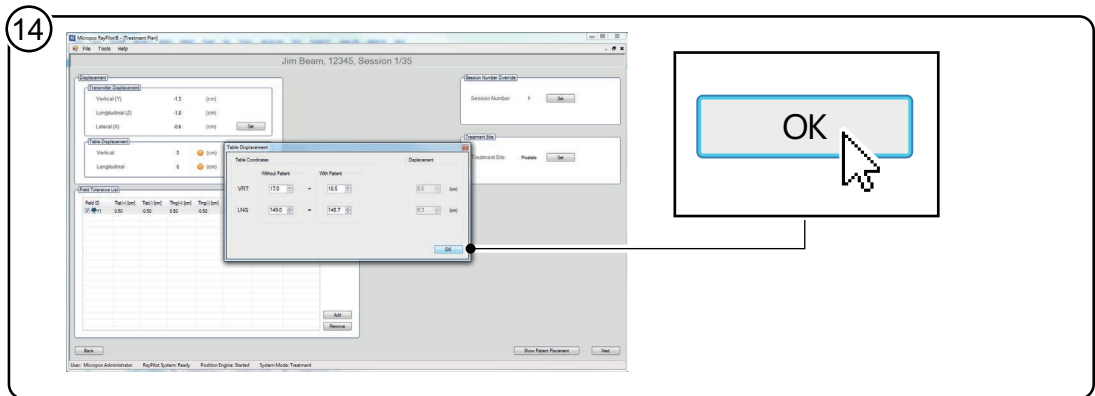
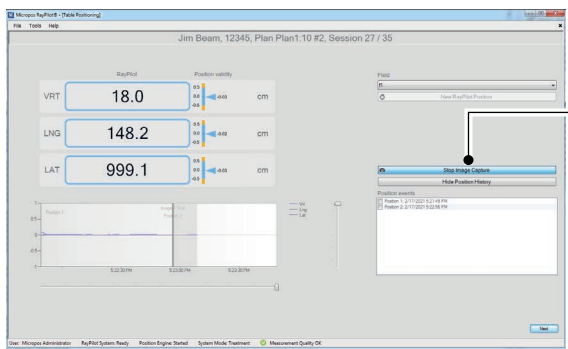

Figure 28 Instructions how to perform table displacement measurement (step 14-16)

### 4.6.3 Patient Set Up Guidance

1



**Start Image Capture**

Start Imaging in the external control system and Image Capture in RayPilot software at the same time. If automatic beam detection is enabled image capture will automatically start when a CBCT is delivered.

2

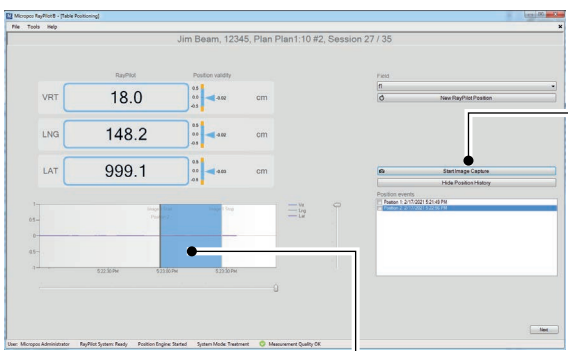

**Stop Image Capture**

When Imaging is completed in the external control system, click Stop Image Capture in RayPilot software. If automatic beam detection is enabled image capture will automatically stop when a CBCT is completed.

**Note!**

If manually stopping image capture while a CBCT is being delivered, the user will be notified.

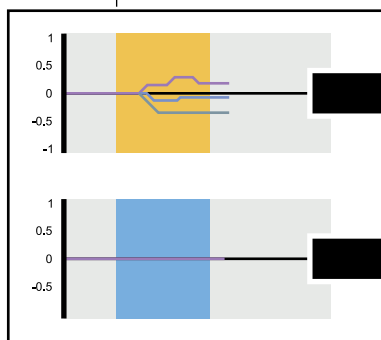

If Image Capture is outside tolerance, repeat step 1-2.

If Image Capture is inside tolerance, proceed to step 3.

Figure 29 Instructions for patient setup guidance (step 1-2)

3

The RayPilot system indicates the couch coordinates for the patient set up. During the setup procedure, the target can move and thereby also the indicated coordinates for patient setup.

4

As long as the target is within tolerance during setup, it is indicated with a blue arrow on the side of coordinate.

If the target moves out of tolerance during setup, it is indicated with a yellow arrow on the side of the coordinate.

New Treatment Position

**Note!**  
If target moves out of position, click the "New Treatment Position"-button to get new coordinates.

5

**Note!**  
Verify the treatment position provided by RayPilot system according to clinical routine.

6

Next

When setup is verified, push the next button in the software interface to move to the real-time monitor.

Figure 30 Instructions for patient setup guidance (step 3-6)

### 4.6.4 Real-time Monitor

1

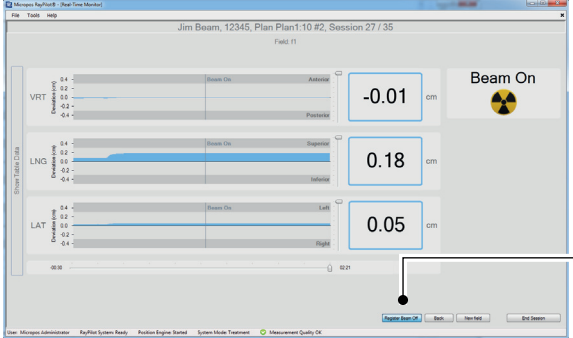

Press Register beam on when treatment beam delivery starts. If automatic beam detection is enabled the start of the treatment beam will automatically be registered.

Register Beam On

2



Press Register beam off when treatment beam delivery ends. If automatic beam detection is enabled the end of the treatment beam will automatically be registered.

Register Beam Off

3

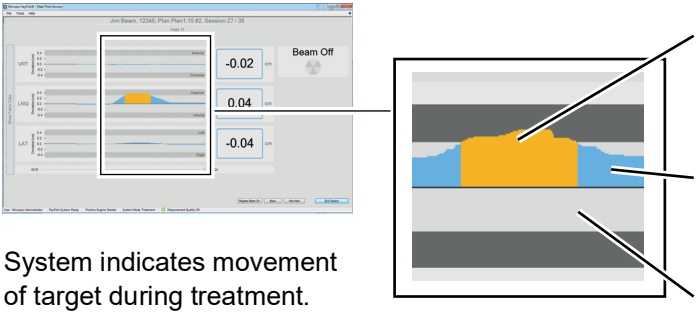

System indicates movement of target during treatment.

- Indicates that target has moved outside field tolerance parameter.
- Indicates that target is inside field tolerance parameters.
- Field tolerance parameters.

Note!

If target moves out of field tolerance parameters, stop treatment. Wait until target moves back in place, or repeat 4.6.3 Patient Set Up Guidance.

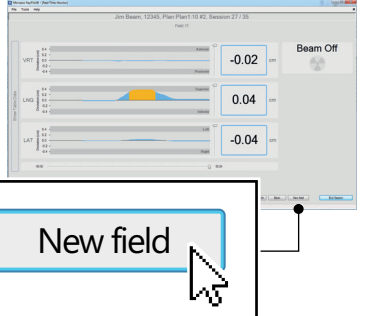

Note!

When changing fields in the linear accelerator, change fields in the RayPilot system software accordingly.

New field

Figure 31 Instructions for real-time monitor (step 1-3)

4

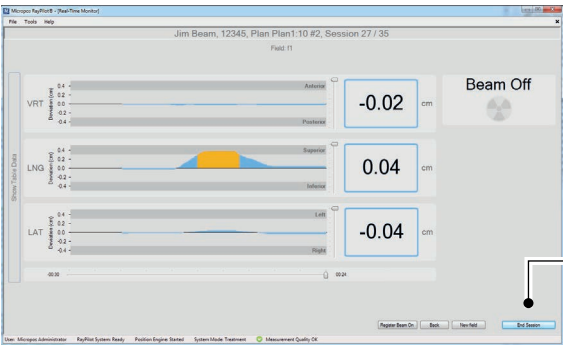

After completed treatment, press the "End Session"-button.

End Session

5



The window shows a summary of the target movement during treatment. Close the window when you are ready.

Close



Figure 32 Instructions for real-time monitor (step 4-5)

---

## 4.7 First Treatment with Table Positioning and Image Synchronization

### 4.7.1 Image Synchronization

With image capture in the RayPilot system, the user can get an indication of whether the target has moved more than the set tolerance during the setup with images.

### 4.7.2 Description

#### Task

The task is to perform patient treatment.

#### Task interval

During treatment.

#### Conditions

Equipment is set up, see 4.1 Set Up Equipment.

User is signed in to RayPilot software, see 3.1 Sign In RayPilot Software.

Patient added to database, see 3.3.2 Add New Patient from DICOM Database.

Daily control has been performed, see 4.2 Daily Quality Control.

Transmitter displacement information has been added, see 4.3 Add Patient Transmitter Displacement.

Field tolerance parameters has been added, see 4.4 Add Field Tolerance Parameters.

Transmitter ID and patient are matched, see 4.5 Match Patient to Transmitter ID.

### 4.7.3 Table Displacement and Patient Placement

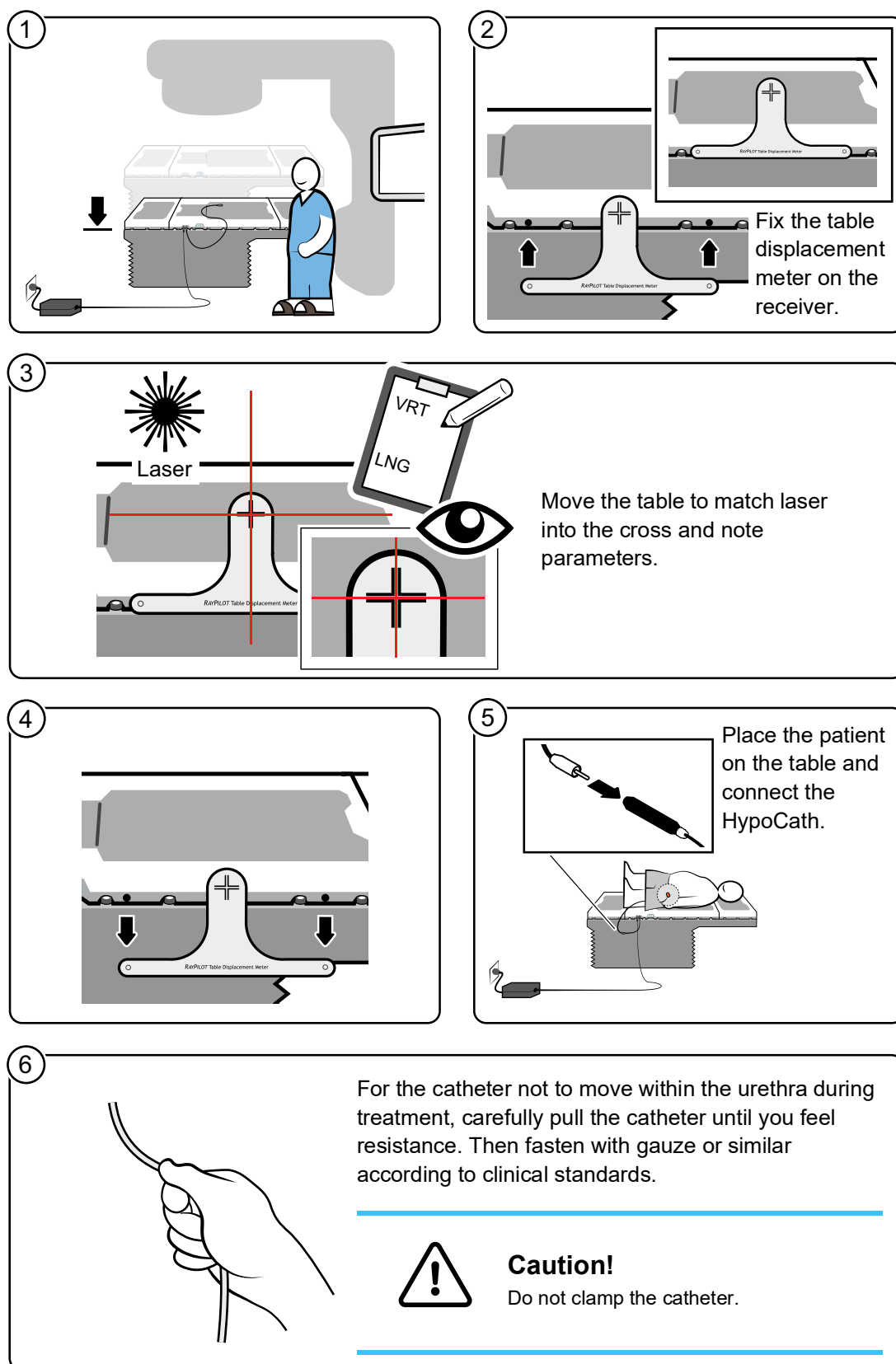



Figure 33 Instructions how to perform table displacement measurement (step 1-6)

7



The connected patient is not matched to any patient data. Would you like to match this patient?

Match the transmitter ID with the patient in software. See 4.5 Match Patient to Transmitter ID.

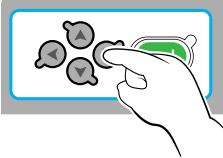

8

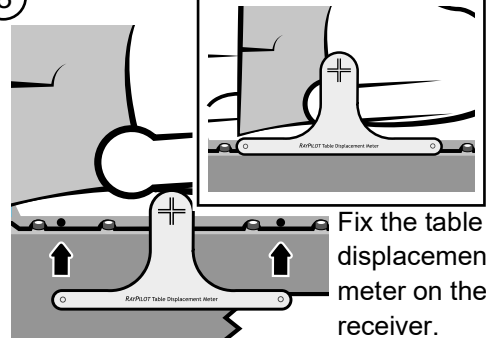

Fix the table displacement meter on the receiver.

9

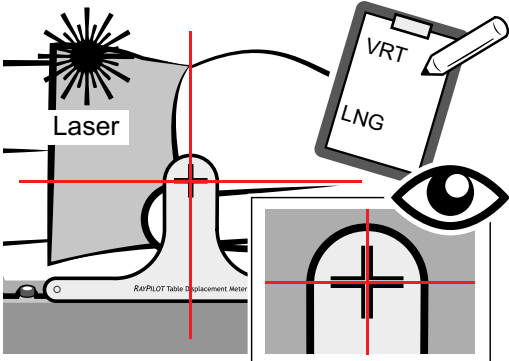

Move the table to match laser into the cross and note parameters.

10

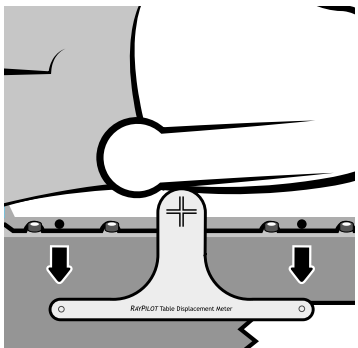

11

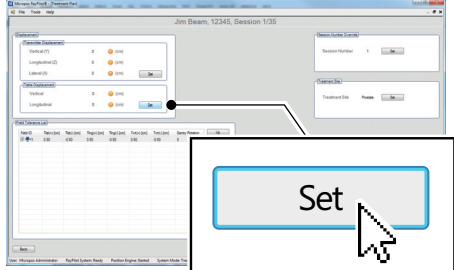

Insert the table displacement values received in step 2-10.

12

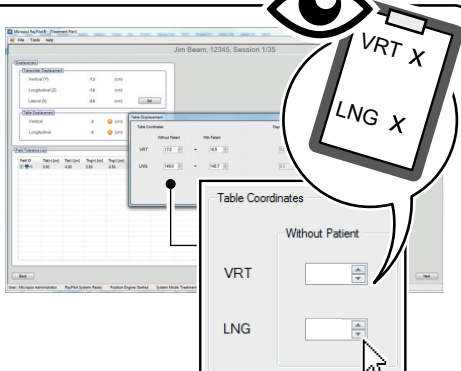

VRT X  
LNG X

Without Patient

VRT

LNG

13

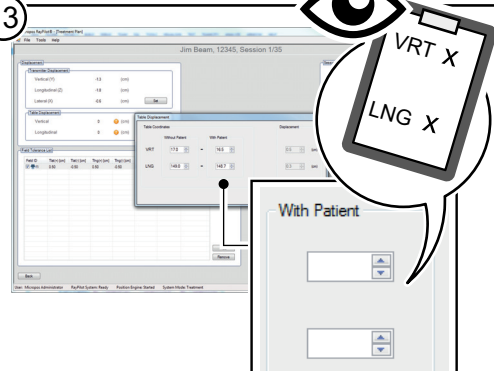

VRT X  
LNG X

With Patient

Figure 34 Instructions how to perform table displacement measurement (step 7-13)

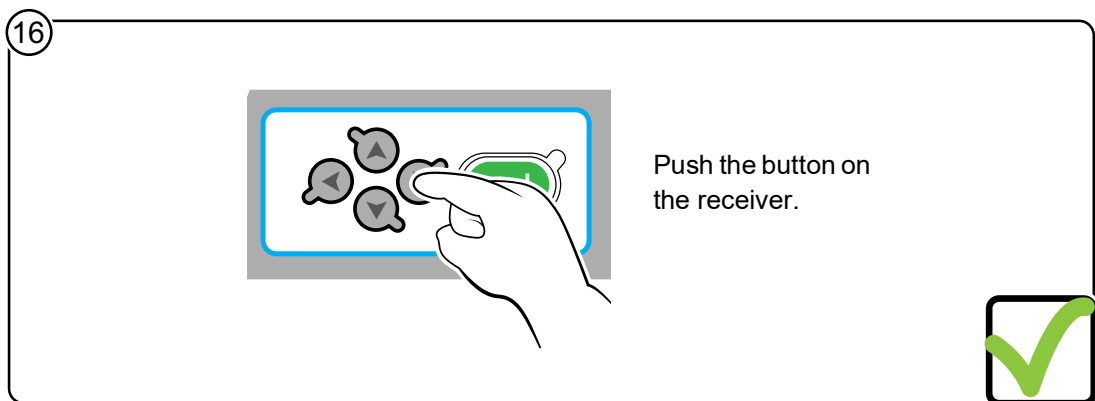
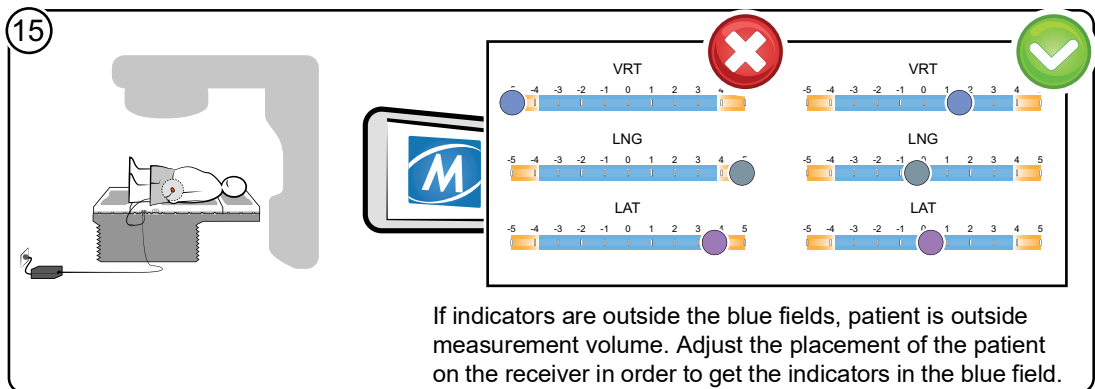
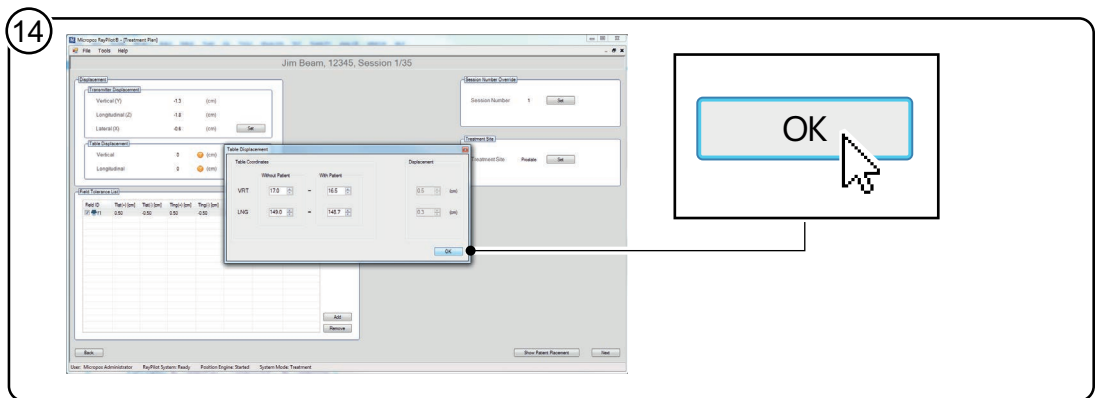
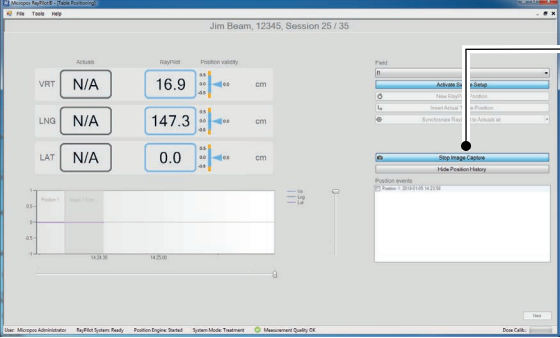

Figure 35 Instructions how to perform table displacement measurement (step 14-16)

#### 4.7.4 Patient Set Up Guidance with Image Synchronization

1



**Start Image Capture**

Start Imaging in the external control system and Image Capture in RayPilot software at the same time. If automatic beam detection is enabled image capture will automatically start when a CBCT is delivered.

2

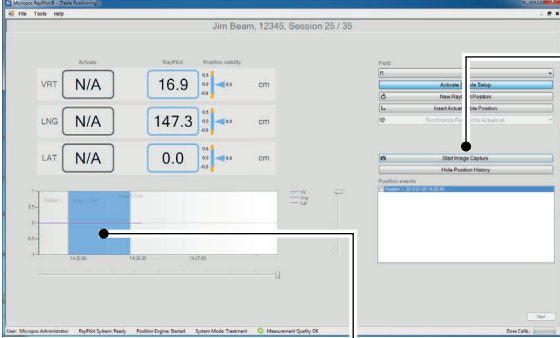

**Stop Image Capture**

When Imaging is completed in the external control system, click Stop Image Capture in RayPilot software. If automatic beam detection is enabled image capture will automatically stop when a CBCT is completed.

**Note!**

If manually stopping image capture while a CBCT is being delivered, the user will be notified.

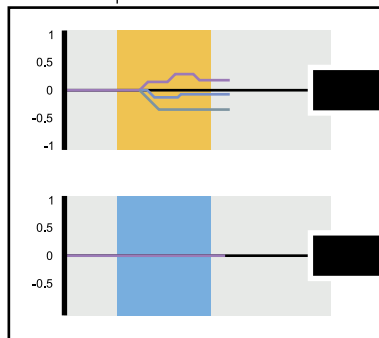

If Image Capture is outside tolerance, repeat step 1-2.

If Image Capture is inside tolerance, proceed to step 3.

3

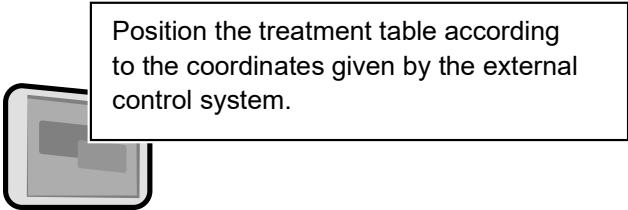

Position the treatment table according to the coordinates given by the external control system.

Figure 36 Instructions for patient setup guidance with image synchronization (step 1-3)

4

Jim Beam, 12345, Session 25 / 35

	Actuals	RayPilot	Position validity
VRT	N/A	16.9	cm
LNG	N/A	147.3	cm
LAT	N/A	0.0	cm

Insert Actual Table Position

If the coordinates setup with external system deviates from the indicated coordinates in RayPilot system, insert the actual position of the treatment table into the RayPilot software.

5

Jim Beam, 12345, Session 25 / 35

	Actuals	RayPilot	Position validity
VRT	16.9	16.9	cm
LNG	147.3	147.3	cm
LAT	0.0	0.0	cm

VRT 16.9

LNG 147.3

LAT 0.0

Use the arrows to adjust the inserted actual table position coordinates if necessary.

6

Jim Beam, 12345, Session 25 / 35

	Actuals	RayPilot	Position validity
VRT	16.9	16.9	cm
LNG	147.3	147.3	cm
LAT	0.0	0.0	cm

Apply Actual Table Position

The actual table position coordinates will be saved to the RayPilot software.

7

Jim Beam, 12345, Session 25 / 35

	Actuals	RayPilot	Position validity
VRT	16.9	16.9	cm
LNG	147.0	147.3	cm
LAT	0.0	0.0	cm

Synchronize RayPilot to Actuals at:

Image 1 Start

Current Time

Synchronize the RayPilot software to Actuals at a specific point in time. For example, when the Image used to position the table was taken.

Figure 37 Instructions for patient setup guidance with image synchronization (step 4-7)

8

The RayPilot system indicates the couch coordinates for the patient set up. During the setup procedure, the target can move and thereby also the indicated coordinates for patient setup.

9

As long as the target is within tolerance during setup, it is indicated with a blue arrow on the side of coordinate.

If the target moves out of tolerance during setup, it is indicated with a yellow arrow on the side of the coordinate.

New Treatment Position

**Note!**  
If target moves out of position, click the "New Treatment Position"-button to get new coordinates.

10

**Note!**  
Verify the treatment position provided by RayPilot system according to clinical routine.

11

Next

When setup is verified, push the next button in the software interface to move to the real-time monitor.

Figure 38 Instructions for patient setup guidance with image synchronization (step 8-11)

## 4.7.5 Real-time Monitor

**1**

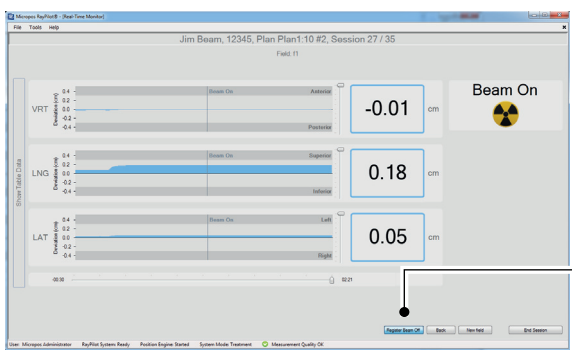

Press Register beam on when treatment beam delivery starts. If automatic beam detection is enabled the start of the treatment beam will automatically be registered.

**Register Beam On**

**2**

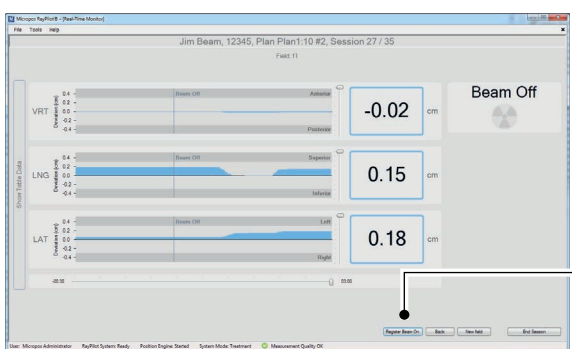

Press Register beam off when treatment beam delivery ends. If automatic beam detection is enabled the end of the treatment beam will automatically be registered.

**Register Beam Off**

**3**

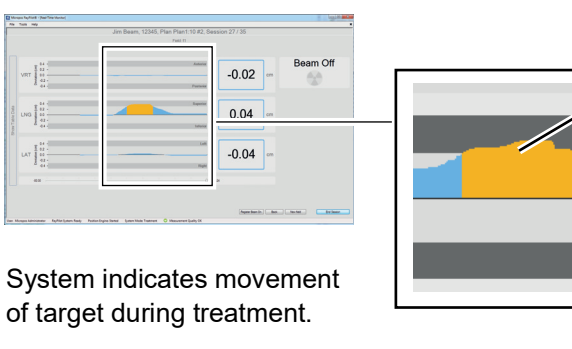

System indicates movement of target during treatment.

- Indicates that target has moved outside field tolerance parameter.
- Indicates that target is inside field tolerance parameters.
- Field tolerance parameters.

**New field**

**Note!**  
If target moves out of field tolerance parameters, stop treatment. Wait until target moves back in place, or repeat 4.6.3 Patient Set Up Guidance.

**Note!**  
When changing fields in the linear accelerator, change fields in the RayPilot system software accordingly.

Figure 39 Instructions for real-time monitor (step 1-3)

4

After completed treatment, press the "End Session"-button.

End Session

5

The window shows a summary of the target movement during treatment. Close the window when you are ready.

Close

Ref	LAT 3Dcm	LAT mean	LNG 3Dcm	LNG mean	VRT 3Dcm	VRT mean
H	0.191	0.192	0.206	0.222	0.074	-0.081

✓

Figure 40 Instructions for real-time monitor (step 4-5)

---

## 4.8 Treatment with Standard Table Positioning

### 4.8.1 Description

#### Task

The task is to perform patient treatment.

#### Task interval

During treatment.

#### Conditions

Equipment is set up, see 4.1 Set Up Equipment.

User is signed in to RayPilot software, see 3.1 Sign In RayPilot Software.

Patient added to database, see 3.3.2 Add New Patient from DICOM Database.

Daily control has been performed, see 4.2 Daily Quality Control.

Transmitter displacement information has been added, see 4.3 Add Patient Transmitter Displacement.

Field tolerance parameters has been added, see 4.4 Add Field Tolerance Parameters.

Transmitter ID and patient are matched, see 4.5 Match Patient to Transmitter ID.

Table displacement has been added, see 4.6.2 Table Displacement and Patient Placement.

## 4.8.2 Patient Placement

1

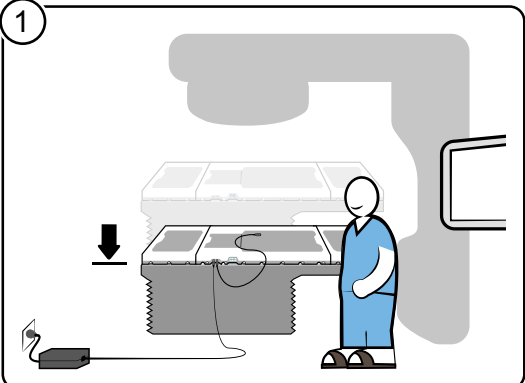

2

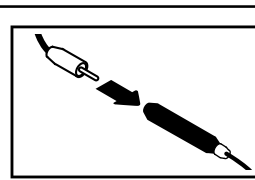

Place the patient on the table and connect the HypoCath.

3

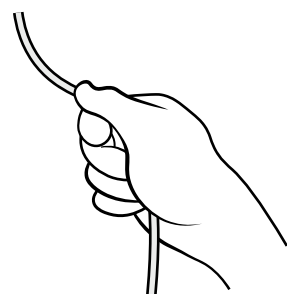

For the catheter not to move within the urethra during treatment, carefully pull the catheter until you feel resistance. Then fasten with gauze or similar according to clinical standards.



**Caution!**  
Do not clamp the catheter.

4

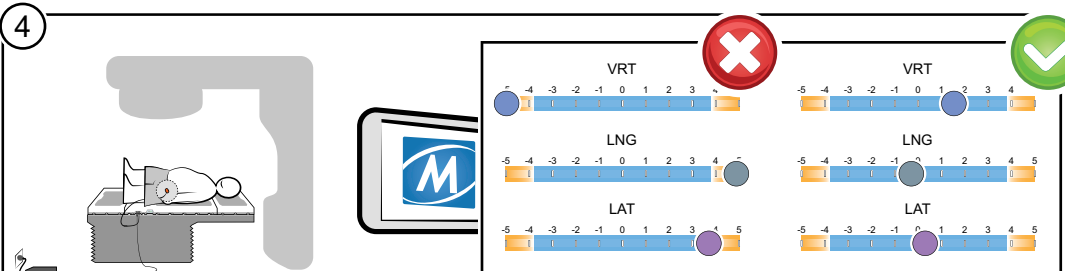

If indicators are outside the blue fields, patient is outside measurement volume. Adjust the placement of the patient on the receiver in order to get the indicators in the blue field.

5

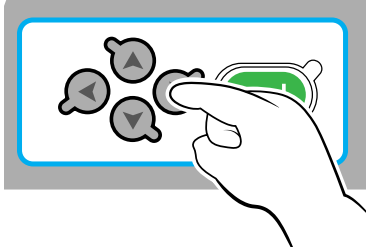

Push the button on the receiver.

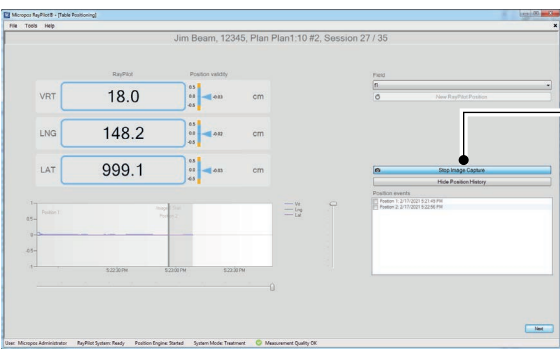

Figure 41 Instructions for patient placement

### 4.8.3 Patient Set Up Guidance

1



**Start Image Capture**

Start Imaging in the external control system and Image Capture in RayPilot software at the same time. If automatic beam detection is enabled image capture will automatically start when a CBCT is delivered.

2

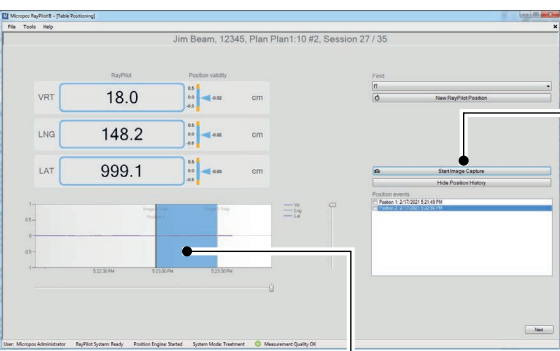

**Stop Image Capture**

When Imaging is completed in the external control system, click Stop Image Capture in RayPilot software. If automatic beam detection is enabled image capture will automatically stop when a CBCT is completed.

**Note!**

If manually stopping image capture while a CBCT is being delivered, the user will be notified.

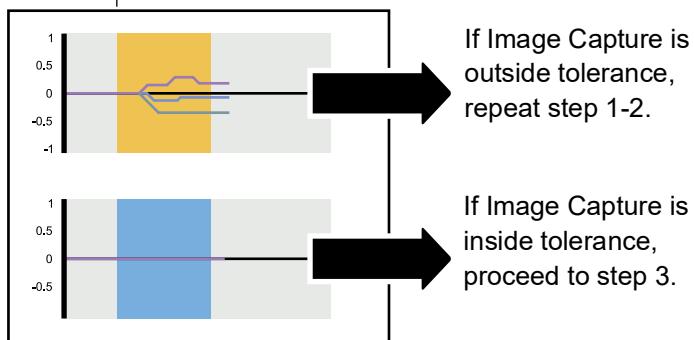

Figure 42 Instructions for patient setup guidance (step 1-2)

3

The RayPilot system indicates the couch coordinates for the patient set up. During the setup procedure, the target can move and thereby also the indicated coordinates for patient setup.

4

As long as the target is within tolerance during setup, it is indicated with a blue arrow on the side of coordinate.

If the target moves out of tolerance during setup, it is indicated with a yellow arrow on the side of the coordinate.

**Note!**  
If target moves out of position, click the "New Treatment Position"-button to get new coordinates.

5

**Note!**  
Verify the treatment position provided by RayPilot system according to clinical routine.

6

When setup is verified, push the next button in the software interface to move to the real-time monitor.

Figure 43 Instructions for patient setup guidance (step 3-6)

### 4.8.4 Real-time Monitor

1

Press Register beam on when treatment beam delivery starts. If automatic beam detection is enabled the start of the treatment beam will automatically be registered.

Register Beam On

2

Press Register beam off when treatment beam delivery end. If automatic beam detection is enabled the end of the treatment beam will automatically be registered.

Register Beam Off

3

System indicates movement of target during treatment.

- Indicates that target has moved outside field tolerance parameter.
- Indicates that target is inside field tolerance parameters.
- Field tolerance parameters.

**Note!**  
 If target moves out of field tolerance parameters, stop treatment.  
 Wait until target moves back in place, or repeat 4.6.3 Patient Set Up Guidance.

**Note!**  
 When changing fields in the linear accelerator, change fields in the RayPilot system software accordingly.

New field

Figure 44 Instructions for real-time monitor (step 1-3)

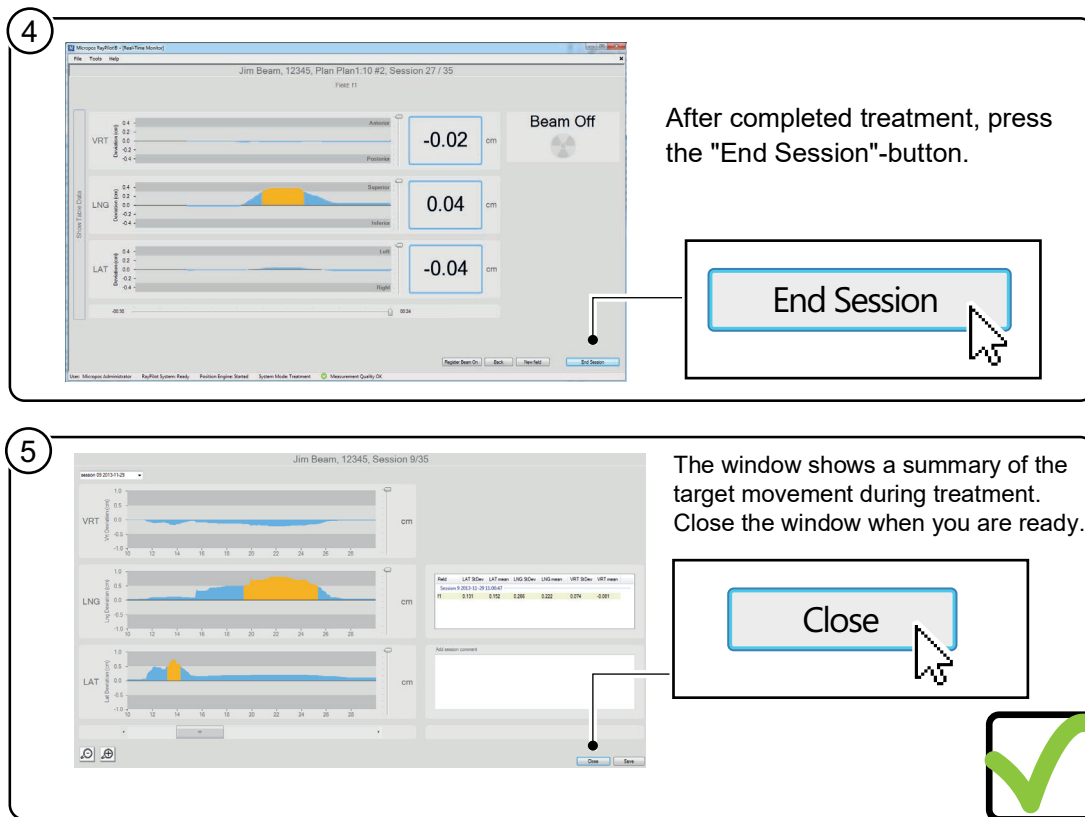

Figure 45 Instructions for real-time monitor (step 4-5)

## 4.9 Treatment with Table Positioning and Image Synchronization

### 4.9.1 Image Synchronization

With image capture in the RayPilot system, the user can get an indication of whether the target has moved more than the set tolerance during the setup with images.

---

## 4.9.2 Description

### Task

The task is to perform patient treatment.

### Task interval

During treatment.

### Conditions

Equipment is set up, see 4.1 Set Up Equipment.

User is signed in to RayPilot software, see 3.1 Sign In RayPilot Software.

Patient added to database, see 3.3.2 Add New Patient from DICOM Database.

Daily control has been performed, see 4.2 Daily Quality Control.

Transmitter displacement information has been added, see 4.3 Add Patient Transmitter Displacement.

Field tolerance parameters has been added, see 4.4 Add Field Tolerance Parameters.

Transmitter ID and patient are matched, see 4.5 Match Patient to Transmitter ID.

Table displacement has been added, see 4.7.3 Table Displacement and Patient Placement.

### 4.9.3 Patient Placement

**1**

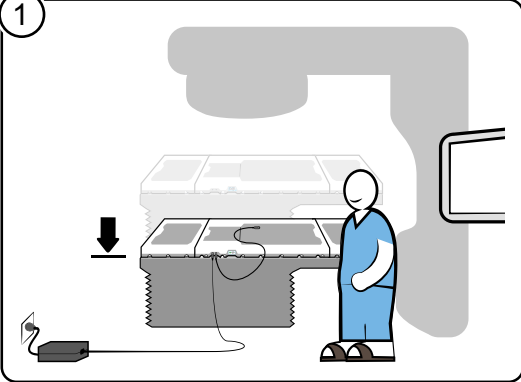

**2**

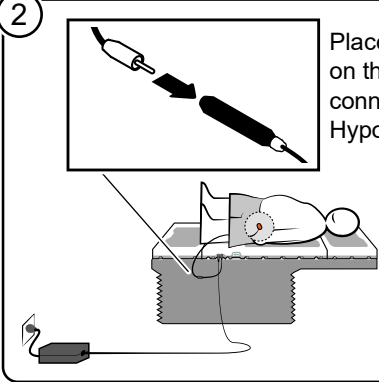

Place the patient on the table and connect the HypoCath.

**3**

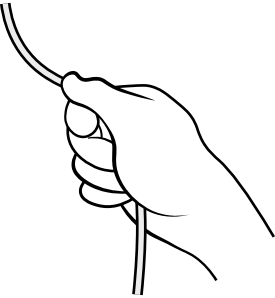

For the catheter not to move within the urethra during treatment, carefully pull the catheter until you feel resistance. Then fasten with gauze or similar according to clinical standards.



**Caution!**  
Do not clamp the catheter.

**4**

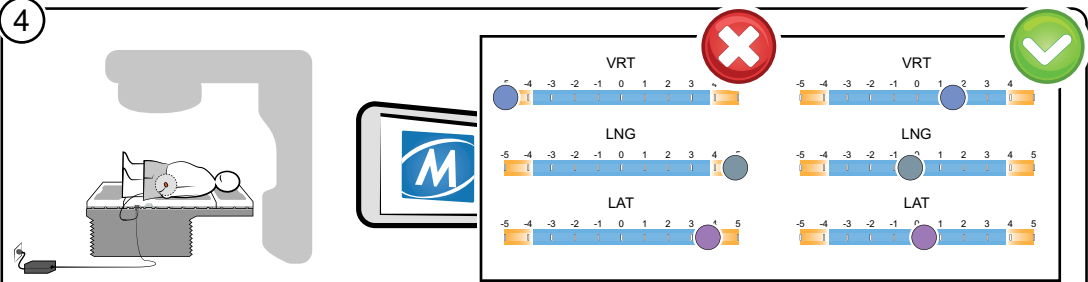

If indicators are outside the blue fields, patient is outside measurement volume. Adjust the placement of the patient on the receiver in order to get the indicators in the blue field.

**5**

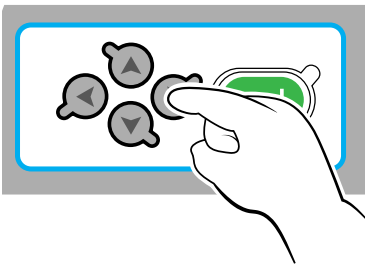

Push the button on the receiver.

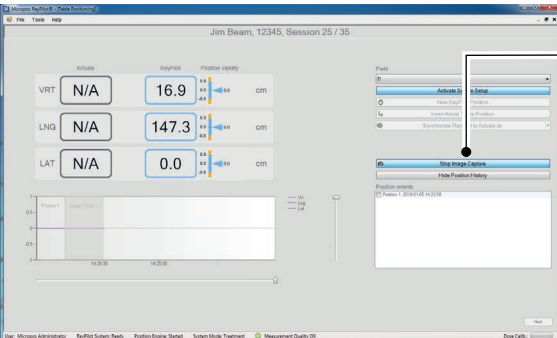

Figure 46 Instructions for patient placement

#### 4.9.4 Patient Set Up Guidance with Image Synchronization

1



**Start Image Capture**

Start Imaging in the external control system and Image Capture in RayPilot software at the same time. If automatic beam detection is enabled image capture will automatically start when a CBCT is delivered.

2

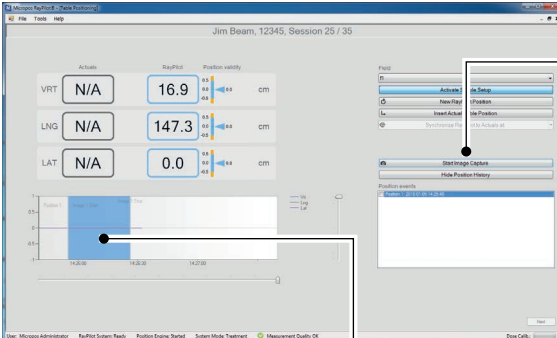

**Stop Image Capture**

When Imaging is completed in the external control system, click Stop Image Capture in RayPilot software. If automatic beam detection is enabled image capture will automatically stop when a CBCT is completed.

**Note!**

If manually stopping image capture while a CBCT is being delivered, the user will be notified.

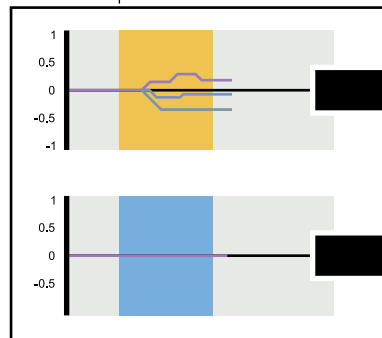

If Image Capture is outside tolerance, repeat step 1-2.

If Image Capture is inside tolerance, proceed to step 3.

3

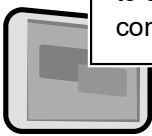

Position the treatment table according to the coordinates given by the external control system.

Figure 47 Instructions for patient setup guidance with image synchronization (step 1-3)

4

Jim Beam, 12345, Session 25 / 35

Actuals	RayPilot	Position validity
VRT N/A	16.9	cm
LNG N/A	147.3	cm
LAT N/A	0.0	cm

Insert Actual Table Position

If the coordinates setup with external system deviates from the indicated coordinates in RayPilot system, insert the actual position of the treatment table into the RayPilot software.

5

Jim Beam, 12345, Session 25 / 35

Actuals	RayPilot	Position validity
VRT 16.9	16.9	cm
LNG 147.3	147.3	cm
LAT 0.0	0.0	cm

VRT 16.9

LNG 147.3

LAT 0.0

Use the arrows to adjust the inserted actual table position coordinates if necessary.

6

Jim Beam, 12345, Session 25 / 35

Actuals	RayPilot	Position validity
VRT 16.9	16.9	cm
LNG 147.3	147.3	cm
LAT 0.0	0.0	cm

Apply Actual Table Position

The actual table position coordinates will be saved to the RayPilot software.

7

Jim Beam, 12345, Session 25 / 35

Actuals	RayPilot	Position validity
VRT 16.9	16.9	cm
LNG 147.0	147.3	cm
LAT 0.0	0.0	cm

Synchronize RayPilot to Actuals at:

Image 1 Start

Current Time

Synchronize the RayPilot software to Actuals at a specific point in time. For example, when the Image used to position the table was taken.

Figure 48 Instructions for patient setup guidance with image synchronization (step 4-7)

8

The RayPilot system indicates the couch coordinates for the patient set up. During the setup procedure, the target can move and thereby also the indicated coordinates for patient setup.

9

As long as the target is within tolerance during setup, it is indicated with a blue arrow on the side of coordinate.

If the target moves out of tolerance during setup, it is indicated with a yellow arrow on the side of the coordinate.

New Treatment Position

**Note!**  
If target moves out of position, click the "New Treatment Position"-button to get new coordinates.

10

**Note!**  
Verify the treatment position provided by RayPilot system according to clinical routine.

11

Next

When setup is verified, push the next button in the software interface to move to the real-time monitor.

Figure 49 Instructions for patient setup guidance with image synchronization (step 8-11)

## 4.9.5 Real-time Monitor

**1**

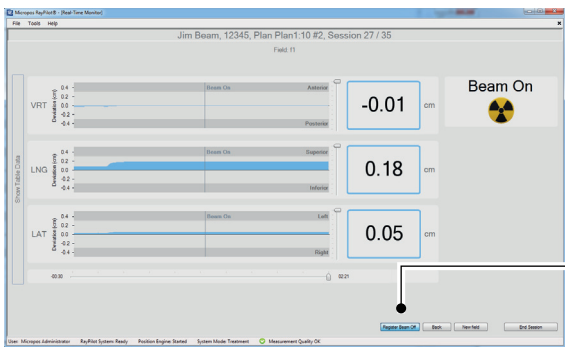

Press Register beam on when treatment beam delivery starts. If automatic beam detection is enabled the start of the treatment beam will automatically be registered.

**Register Beam On**

**2**

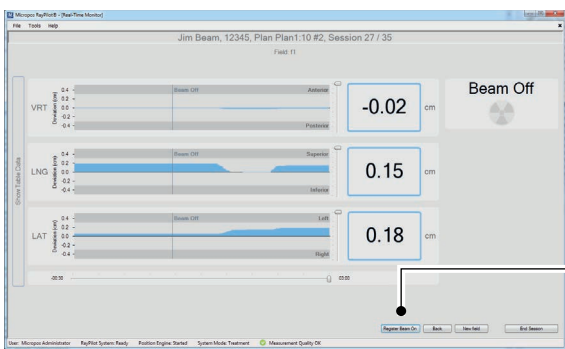

Press Register beam off when treatment beam delivery ends. If automatic beam detection is enabled the end of the treatment beam will automatically be registered.

**Register Beam Off**

**3**

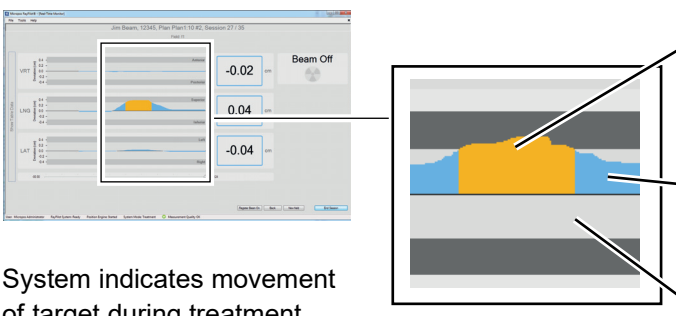

System indicates movement of target during treatment.

- Indicates that target has moved outside field tolerance parameter.
- Indicates that target is inside field tolerance parameters.
- Field tolerance parameters.

**Note!**  
If target moves out of field tolerance parameters, stop treatment. Wait until target moves back in place, or repeat 4.6.3 Patient Set Up Guidance.

**Note!**  
When changing fields in the linear accelerator, change fields in the RayPilot system software accordingly.

**New field**

Figure 50 Instructions for real-time monitor (step 1-3)

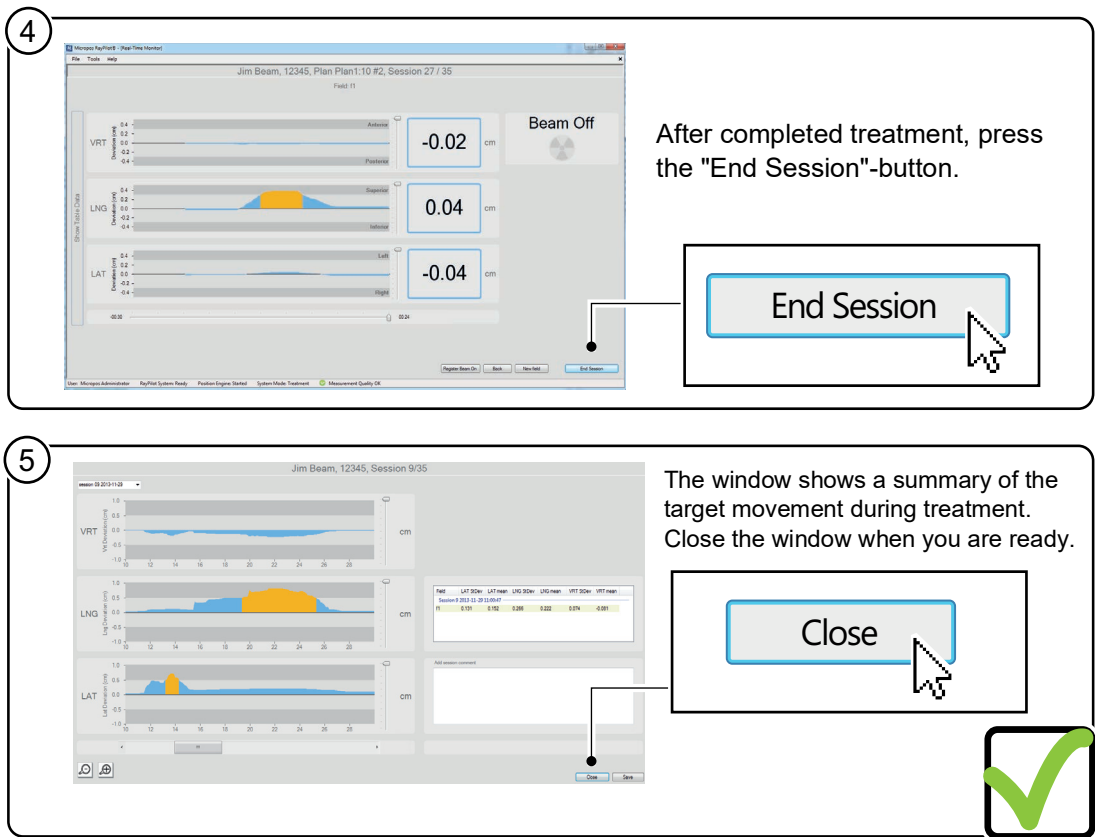

Figure 51 Instructions for real-time monitor (step 4-5)

---

## 4.10 Daily Shut Down Routine

### 4.10.1 Description

#### Task

The task is to remove RayPilot receiver.

#### Task interval

Post-treatment.

#### Conditions

No specific condition for this task.

## 4.10.2 Instructions

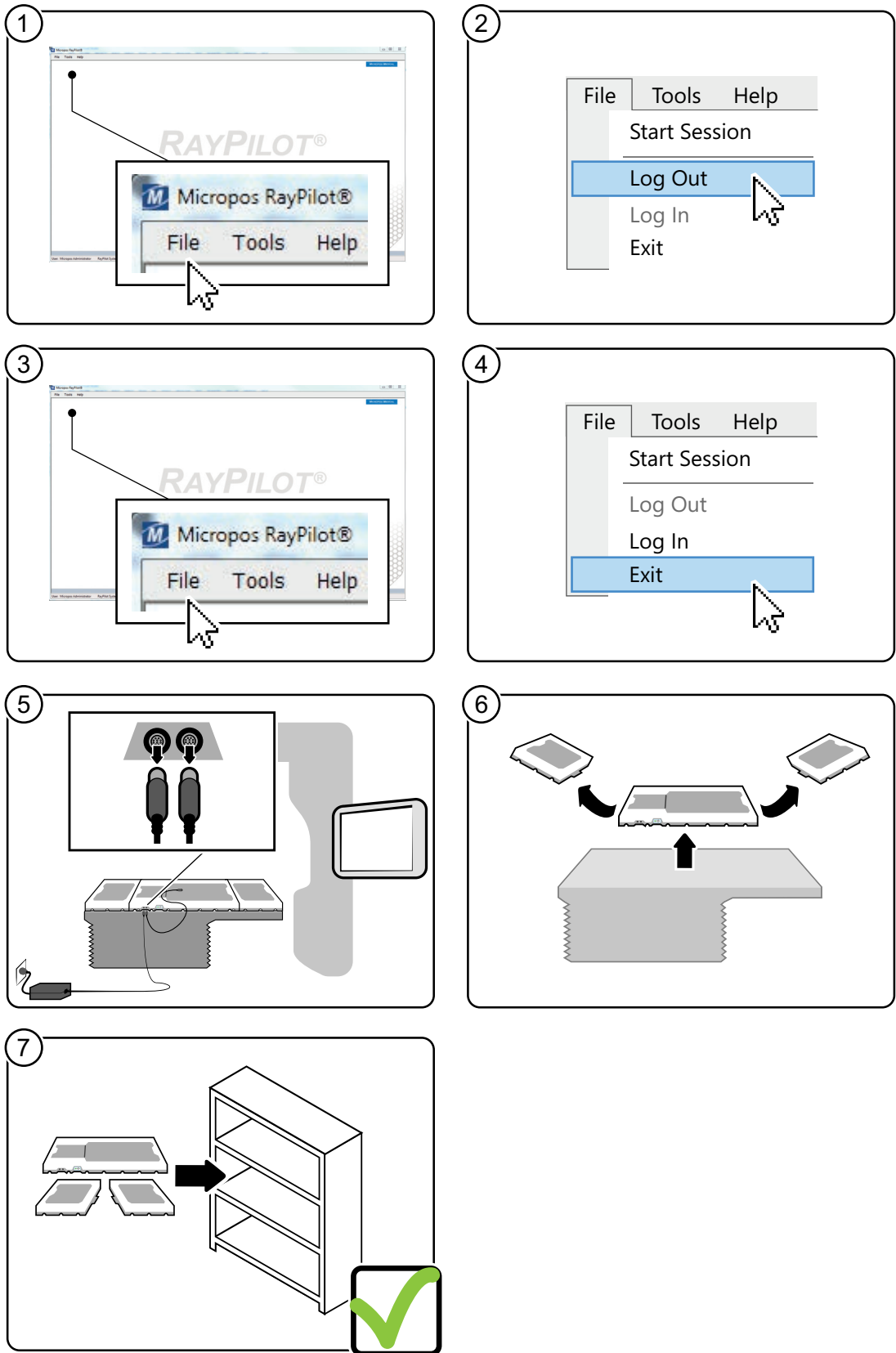

Figure 52 Instructions for daily shut down routine

---

## 4.11 Storage and Backup

3. To backup the RayPilot data, copy the folder C:\Backup.

The folder contains the following databases:

- **RayPilotPatientRecordsDB**  
Includes all the motion data and configurations used during all treatment sessions for each patient.
- **MicroposRayPilotDB**  
Includes all the installation data, patient-specific data for the moment of backup (ID data, field data, etc.).
- **RayPilotDicom**  
Includes all the Dicom-RT information sent to the RayPilot system (moved to Micropos RayPilot DB when imported).
- **RayPilotPatientDdepersonalizerDB**  
Includes the register mapping patient id to id used for anonymizing patient data.

The databases are stored in the .bak file format.

The data can be restored by following Microsoft procedures for restoring databases using Microsoft SQL server.

## 4.12 Multi Room Installation

### 4.12.1 Description

#### Task

The task is to gain knowledge about multiple room installation.

#### Task interval

Pre-treatment.

#### Conditions

Daily quality control is required for the specific system in the specific room before use, see 4.2 Daily Quality Control.

Transmitter displacement information has been added, see 4.3 Add Patient Transmitter Displacement.

#### 4.12.2 Instructions

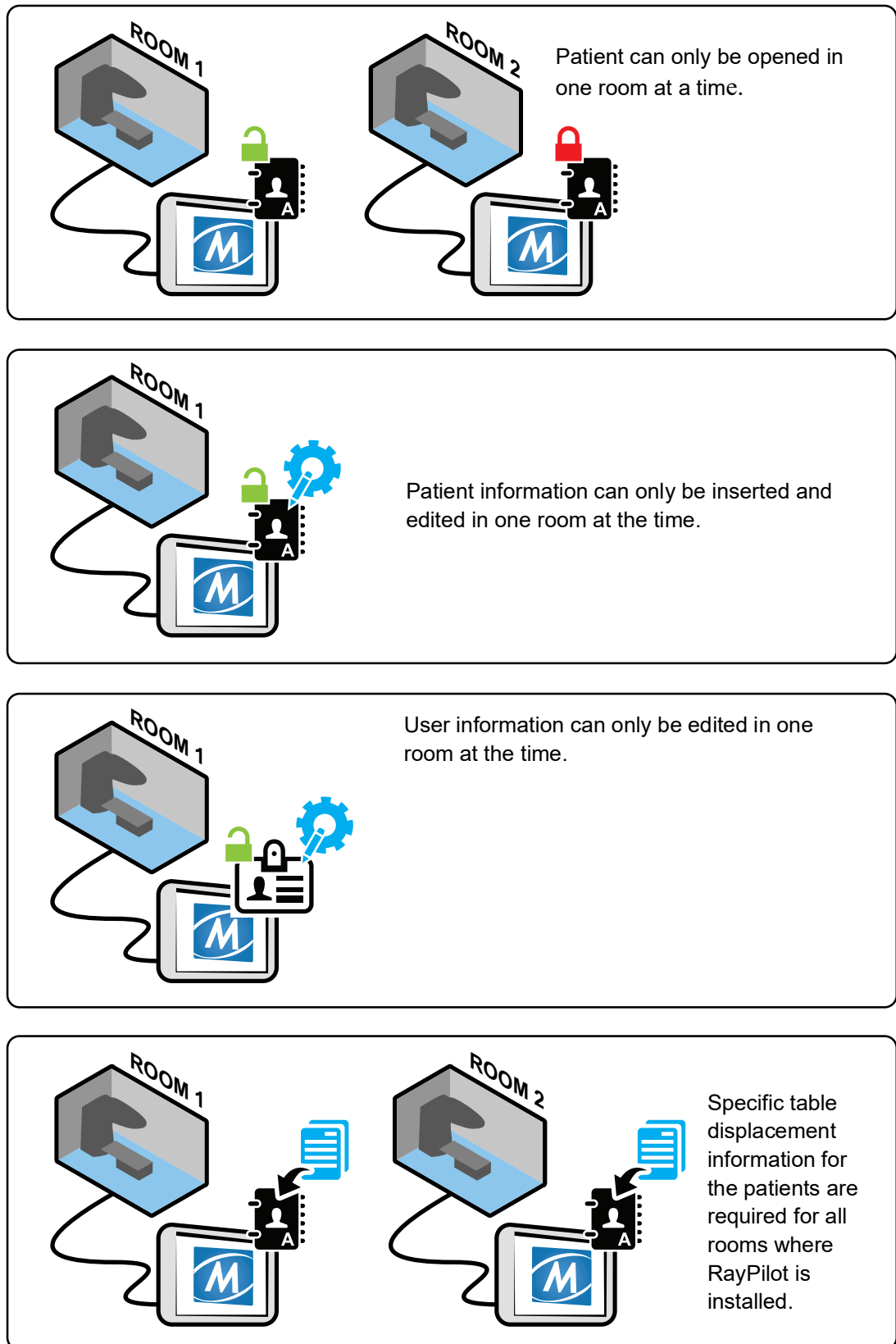

Figure 53 Instructions for multi room installation

---

# 5 Maintenance

## 5.1 Cleaning Equipment After Treatment

### 5.1.1 Description

#### Task

The task is to clean the equipment after treatment.

#### Task interval

Post-treatment.

#### Conditions

System is shut down, see 4.6 First Treatment with Standard Table Positioning.

Comply with local cleaning regulations.

Use a damp cloth (paper or cotton) soaked with water or alcohol (Ethanol 70-96%) to clean the system (see parts in section 5.1.2 Instructions).

## 5.1.2 Instructions

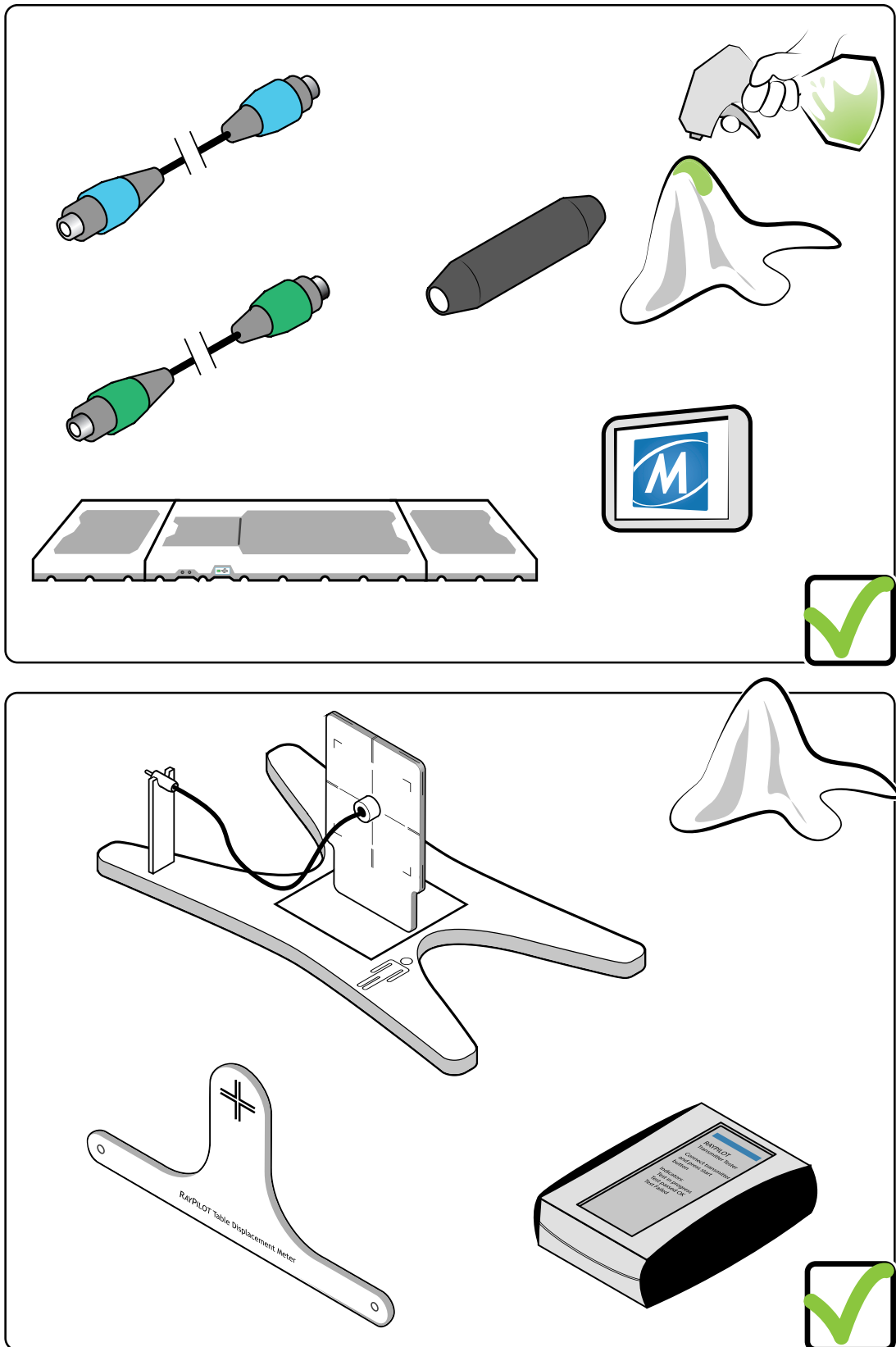

Figure 54 Instructions for cleaning of equipment

# 6 Troubleshooting

## 6.1 Equipment Problems

If you suspect problems with the functioning or operational safety of your RayPilot system, switch it off and contact Micropos Medical or a qualified technician immediately.

If the RayPilot system is not functioning, a plan without considering the treatment with the use of realtime monitoring of the target has to be created.

## 6.2 Error and Warning Messages

Error messages may be displayed during use of the system. A dialog box specifies the error.

If Measurement Quality indicators appears red during table positioning or real time monitor, it indicates an error. Double click the measurement quality indicator to open patient placement window for more error information.

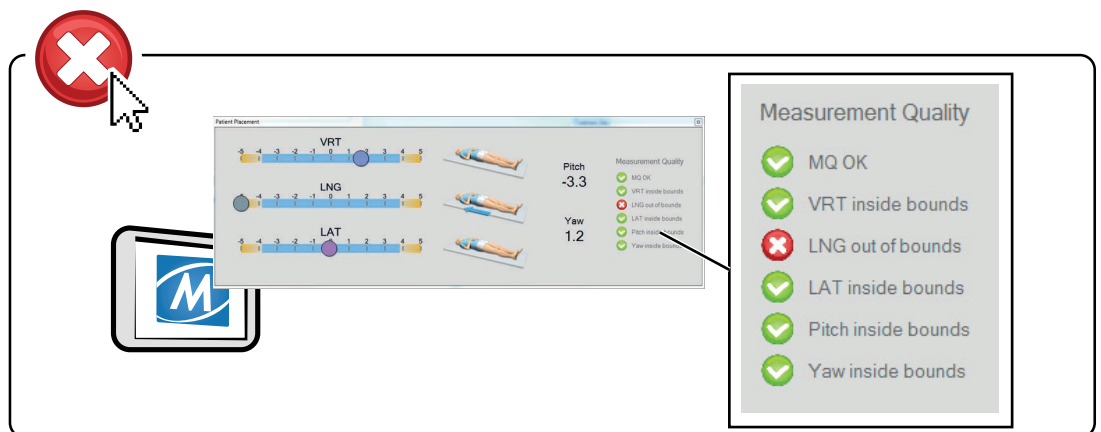

Figure 55 Example of error message when measurement quality indicator appears red

Measurement	Error message	Error description	Solution
MQ	out of bounds	Transmitter to far outside measurement volume.	Move patient closer to measurement volume.
VRT	out of bounds	Transmitter outside measurement volume.	Move patient along the VRT axis closer to measurement volume.
LNG	out of bounds	Transmitter outside measurement volume.	Move patient along the LNG axis closer to measurement volume.
LAT	out of bounds	Transmitter outside measurement volume.	Move patient along the LAT axis closer to measurement volume.

Measurement	Error message	Error description	Solution
Pitch	out of bounds	Transmitter outside measurement volume.	Reposition patient closer to measurement volume.
Yaw	out of bounds	Transmitter outside measurement volume.	Reposition patient closer to measurement volume.

Table 6 List of error descriptions

A 3D representation of the Measurement volume and where the transmitter is located can be found under Tools – Measurement volume 3D.

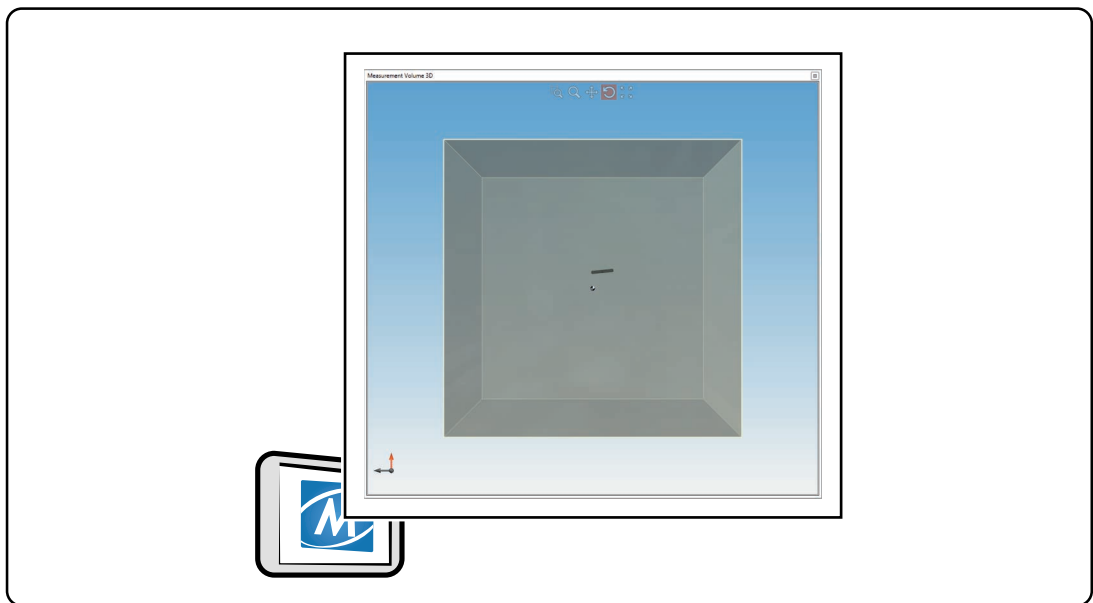

Figure 56 Measurement volume 3D

Apart from the transmitter being outside the measurement volume as in the example in figure 6-48, where the transmitter is out of bounds in the longitudinal direction, the measurement quality indicator warns for unreliable data if the system is not connected properly or if there is an external disturbance, such as metal objects or incompatible fixation equipment, in the vicinity of the system.

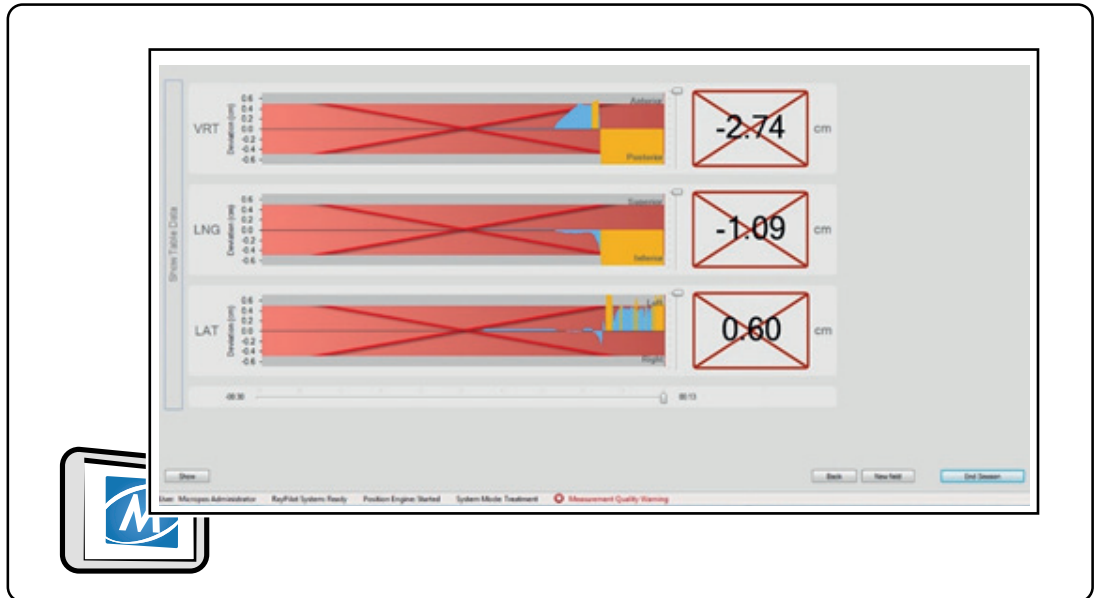

Figure 57 Example of how the error is displayed in the RayPilot Software user interface in real-time monitoring.

Further, the measurement quality indicator is also a warning if there is a mechanical failure or degradation in the system which influences the system performance.

## 6.2.1 Communication Problem with the RayPilot Receiver System

This error message occurs when there is a communication problem with the system.

### Error message

Connection error with RayPilot receiver. The system can not recover and needs to end the session

### Solution

1. Stop the treatment session (shut down the radiation from the radiotherapy device).
  2. Click on Close, and the session will close automatically.
  3. Disconnect the RayPilot system cable.
  4. Connect the RayPilot system cable again.
  5. Restart the treatment, see 4.6 First Treatment with Standard Table Positioning.
- Note! The new session replaces the one that was closed.

Table 7 Procedure when there is a problem with the RayPilot receiver

Open system status window for service communication with Micropos Medical representative, if the error can not be resolved.

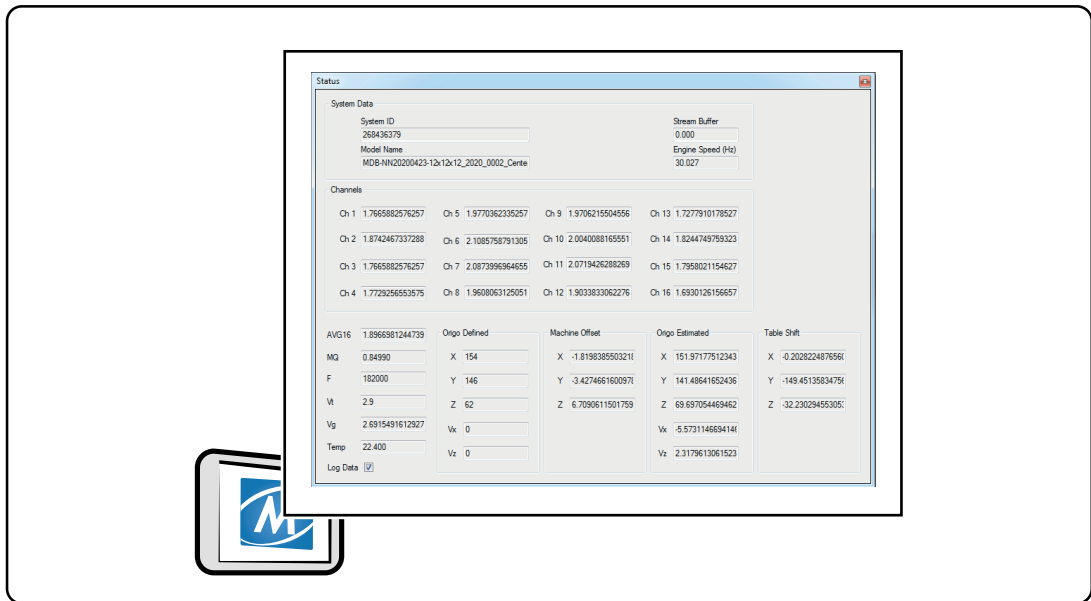

Figure 58 System status window

## 6.2.2 Communication Lost with the Transmitter

This error message occurs when the system has lost contact with the transmitter.

Error message	Solution
 <p>The HypoCath is not properly connected.</p>	<ol style="list-style-type: none"> <li>1. Place the patient in correct position. If the window closes, continue treatment.</li> <li>2. Disconnect the transmitter cable from the HypoCath.</li> <li>3. Connect the transmitter cable to the HypoCath again.</li> <li>4. Check that the system is functioning correctly by performing a quality control test, see 4.2 Daily Quality Control.</li> <li>5. Check the functioning of the HypoCath by using a transmitter tester, see 6.3 RayPilot Transmitter Errors.</li> <li>6. Contact next level of maintenance support.</li> </ol>

Table 8 Procedure when there is a problem with the transmitter

## 6.2.3 Communication Problem with Automatic Patient Identification

Error message	Solution
Connected transmitter is already matched with other patient data.	1. Switch the match to selected patient data.
The selected patient data is already matched with another transmitter.	1. Switch the match to the connected transmitter.
Broken ID chip.	<ol style="list-style-type: none"> <li>1. Double click on "Position Engine [status]".</li> <li>2. Use the drop down list and select the position engine that matches the transmitter and measurement volume that you intend to use in the treatment.</li> </ol>
Connected transmitter does not match any patient data.	1. Match transmitter with patient data, see 4.5 Match Patient to Transmitter ID.
Connected transmitter does not match the currently selected patient data.	<ol style="list-style-type: none"> <li>1. Select correct patient data.</li> <li>2. Create new patient data, see 3.3.2 Add New Patient from DICOM Database.</li> </ol>

Table 9 Procedure when there is a problem with the automatic patient identification

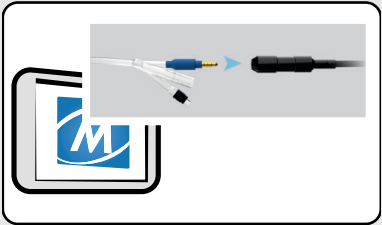
## 6.3 RayPilot Transmitter Errors

If you suspect that the transmitter is damaged, use the transmitter tester to test its function.

1. Connect the transmitter to the transmitter tester and press the button.
2. The transmitter status is shown in the form of LEDs that light up (see the label on the transmitter tester for status descriptions)

If the transmitter status is not shown, verify that the transmitter tester is functioning correctly using the calibration transmitter, or use another transmitter tester. If an error is found with the transmitter, the transmitter must not be used for positioning.

---

If the transmitter function is lost, change the RayPilot HypoCath in the patient to be able to continue treatment with the RayPilot system. Match the new transmitter ID with the patient, see 4.5 Match Patient to Transmitter ID.

---

## 7 Appendix: Technical Specifications

### RayPilot receiver:

Height:	30 mm
Width:	520 mm
Length:	1100 mm
Weight:	10 kg

### RayPilot HypoCath:

Length:	430 mm (including connector)
Width:	16 Fr
IP classification:	IP57

### Position update performance:

Update frequency:	30 times/s
-------------------	------------

### Measurement volume\*:

Measurement volume:	120 x 120 x 120 mm
Measurement height:	From 64 to 184 mm (from RayPilot receiver surface)
*Delivered calibrated according to this measurement volume. Other volumes upon request.	

### Measurement precision:

Radial error:	P95 < 2 mm
Pitch:	+/- 40 degrees: +/- 5%
Yaw:	+/- 40 degrees: +/- 5%

### Environmental conditions:

The environmental conditions are only relevant for use and storage since the system is released and tested after transport.

Temperature:	The device is considered safe at a temperature, +10°C to +40°C.
Humidity:	The RayPilot system is considered safe at a relative humidity level of 30% to 75%.
Pressure:	The device is considered safe at an atmospheric pressure range of 70,0 kPa to 106,0 kPa.

#### Note!

RayPilot HypoCath is classified as IP57.

---

**Operating frequency:**

Transmitter:	123kHz; 13,62 dB $\mu$ V/m (at 3m), no modulation
--------------	---

---

## 8 Appendix: Classification and Compliance

The following section contains information about the compliance of the RayPilot System with relevant standards. This section also contains information about the terms and conditions of installation and operation that have to do with electromagnetic immunity and electromagnetic radiation.

### 8.1 CE Marking



Compliance with the Medical Devices Directive 93/42/EEC.

### 8.2 Electric Shock Protection

Complies with IEC 60601-1:2005 + A1:2012 (SS-EN 60601-1:2006 + A1:2013), Class I, Type BF Applied Part. The parts connected to the patient are insulated against electric shock in accordance with EN 60601-1.

### 8.3 Requirements IEC 60601-1

The product does not have an essential performance as defined in the IEC 60601-1. Basic safety is fulfilled by incorporating 2xMOPP degree of isolation in the Power Supply unit.

Basic safety was monitored during each test by:  
Visual observation of device and measurement accuracy observed via RayPilot software.

### 8.4 Electromagnetic Compatibility and Leakage Current

The RayPilot System complies with the requirements in IEC 60601-1-2:2014 + A1:2020 (EN 60601-1-2:2015 + A1:2021).

The RayPilot system has been tested in accordance with IEC 60601-1-2:2014 + A1:2020 (EN 60601-1-2:2015 + A1:2021) with respect to electromagnetic compatibility. In addition, RayPilot has been tested in accordance with SS-EN 60601-1:2006 + A1: 2013 with respect to leakage current. The tables below show compliance with a range of test variables in the referenced IEC basic standards.

RayPilot system shall be used in Professional Healthcare Environment. RayPilot system is intended for use in an electromagnetic environment as specified in following subsections. The customer or the user of the RayPilot system must assure that it is used in such an environment.

---

### 8.4.1 Emission

Test	Limit	Electromagnetic environment - guidance
Conducted emission	CISPR 11, Group 1, Class A	Device uses RF energy only for its internal function. Therefore, its RF emissions are very low and are not likely to cause any interference in nearby electronic equipment.
Radiated emission	CISPR 11, Group 1, Class A	
Harmonic current emissions	IEC 61000-3-2, Class A	/
Voltage fluctuations and flicker	IEC 61000-3-3	

**Note!**

The EMISSIONS characteristics of this equipment make it suitable for use in industrial areas and hospitals (CISPR 11 class A). If it is used in a residential environment (for which CISPR 11 class B is normally required) this equipment might not offer adequate protection to radio-frequency communication services. The user might need to take mitigation measures, such as relocating or re-orienting the equipment.

**Note!**

Specification level, Radial error  $\leq 2\text{mm}$  during testing. Measurement quality warning is acceptable.

**Note!**

RayPilot system shall be used in Professional Healthcare Environment.

## 8.4.2 Immunity Test Levels

Test	Compliance level	Electromagnetic environment - guidance
Electrostatic Discharge (IEC 61000-4-2)	Contact Discharge: ±8 kV Air Discharge: ±2 kV, ±4 kV, ±8 kV, ±15 kV	Floors should be wood, concrete or ceramic tile. If floors are covered with synthetic material, the relative humidity should be at least 30%.
Radiated RF EM field (IEC 61000-4-3)	80-2700 MHz; 1kHz AM 80%; 3 V/m	Portable and mobile RF communications equipment should be used no closer to any part of the device, including cables, than the recommended separation distance calculated from the equation applicable to the frequency of the transmitter.  <b>Recommended separation distance</b>  $d = 1.2\sqrt{P}$ for 80 MHz to 800 MHz $d = 2.3\sqrt{P}$ for 800 MHz to 2,7 GHz  where P is the maximum output power rating of the transmitter in watts (W) according to the transmitter manufacturer and d is the recommended separation distance in meters (m).
Proximity fields from RF wireless communications equipment (IEC 61000-4-3)	385 MHz; Pulse Modulation: 18 Hz; 27 V/m 450 MHz, FM + 5 Hz deviation: 1 kHz sine; 28 V/m 710, 745, 780 MHz; Pulse Modulation: 217 Hz; 9 V/m 810, 870, 930 MHz; Pulse Modulation: 18 Hz; 28 V/m 1720, 1845, 1970 MHz; Pulse Modulation: 217 Hz; 28 V/m 2450 MHz; Pulse Modulation: 217 Hz; 28 V/m; 5240, 5500, 5785 MHz; Pulse Modulation: 217 Hz; 9 V/m	Portable and mobile RF communications equipment should be used no closer to any part of the device, including cables, than the recommended separation distance 30 cm.
Electrical fast transients / bursts (IEC 61000-4-4)	Power lines: 2kV; 100 kHz repetition frequency Signal lines: 1kV; 100 kHz repetition frequency	Mains power quality should be that of a typical environment.
Surges (IEC 61000-4-5)	L-N: 1kV L-PE, N-PE: 2kV	Mains power quality should be that of a typical environment.

Test	Compliance level	Electromagnetic environment - guidance
Conducted disturbances induced by RF fields (IEC 61000-4-6)	0.15-80 MHz; 1kHz AM 80 %; 3 Vrms, 6 Vrms in ISM and amateur radio band	<p>Portable and mobile RF communications equipment should be used no closer to any part of the device, including cables, than the recommended separation distance calculated from the equation applicable to the frequency of the transmitter.</p> <p>Recommended separation distance</p> <p><math>d = 1.2\sqrt{P}</math> for 150 kHz to 80MHz</p> <p>where P is the maximum output power rating of the transmitter in watts (W) according to the transmitter manufacturer and d is the recommended separation distance in meters (m).</p>
Rated power frequency magnetic fields (IEC 61000-4-8)	30 A/m, 50 Hz	Power frequency magnetic fields should be at levels characteristic of a typical location in a typical commercial or hospital environment.
Voltage dips / Voltage interruptions (IEC 61000-4-11)	0% UT for 0.5 cycle at 0°, 45°, 90°, 135°, 180°, 225°, 270°, 315° 0% UT for 1 cycle at 0° 70% UT for 25/30 cycles at 0° 0% UT for 250/300 cycles 0°	Mains power quality should be that of a typical environment. If the user of the device requires continued operation during power mains interruptions, it is recommended that the device is powered from an uninterruptible power supply or battery.
Proximity magnetic fields IEC 61000-4-39	134,2kHz Pulse modulation 2,1kHz; 65A/m 13,56MHz Pulse modulation 50kHz; 7,5A/m	The recommended separation distance between the RayPilot system and RFID or similar devices is at least 15 cm.



## CONTACT

Micropos Medical AB (publ)  
Adolf Edelsvärds gata 11  
SE-414 51 Gothenburg  
Sweden

[info@micropos.se](mailto:info@micropos.se)  
[www.micropos.se](http://www.micropos.se)

